



NESPRESSO® N90/N9

Instructions for use



Legend:

- **DISPLAY** DISPLAY: serves as information.
- **DISPLAY** **DISPLAY**: please follow the instructions shown.

 = Note

 = Important

 = Tip



Fig. 1



Fig. 2



Fig. 3



Fig. 4



Fig. 5



Fig. 6

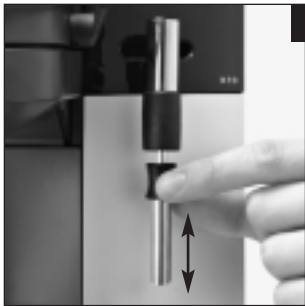

Fig. 7

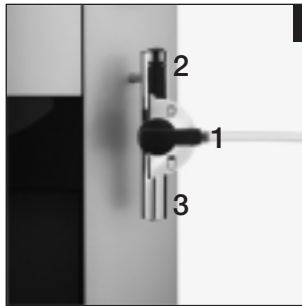

Fig. 8

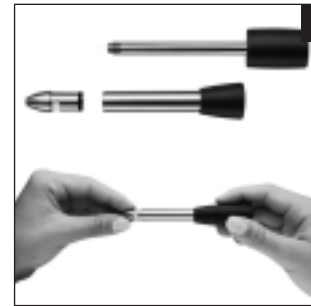
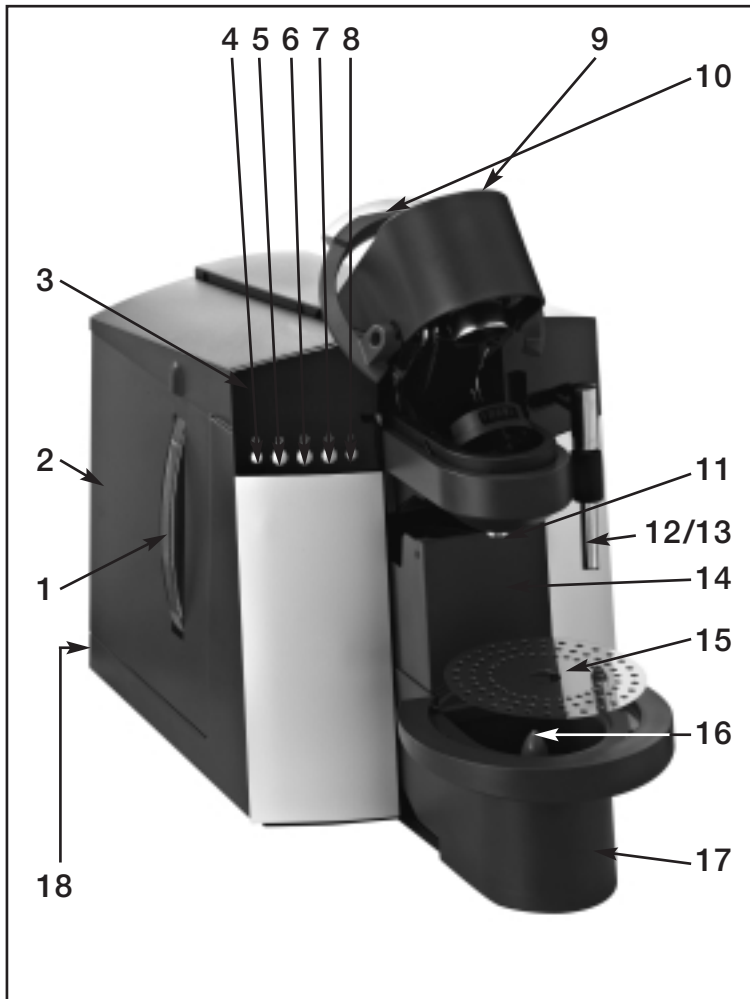

Fig. 9



Description of machine:

1. Water tank filling level indicator
2. Water tank with handle
3. Display dialogue system / control panel
4. ON/OFF key
5. Draw-off key small cup (arrow key)
6. Draw-off key large cup
7. Steam selection key (arrow key)
8. Programming key
9. Hot water / steam valve (Fig.3/4)
10. Shackle
11. Coffee spout
12. Replaceable steam / frothing jet (Fig. 7)
13. Replaceable hot water jet
14. Capsule container
15. Drip grate
16. Water filling level indicator
17. Drip tray
18. Power switch

Contents

JURA NESPRESSO N90/N9

1. Description of the machine.....	page 6	13. Switching off machine	page 12
2. Safety information	page 6	14. Adjusting the water quantity for coffee	page 12
2.1 Warning.....	page 6	15. Programming	page 12
2.2 Precautions.....	page 6	15.1 Programming the filter	page 12
2.2 Power switch	page 7	15.2 Programming the water hardness.....	page 12
3. First steps.....	page 7	15.3 Programming the steam portion	page 13
3.1 Check the mains voltage.....	page 7	15.4 Programming the water portion	page 13
3.2 Check electrical fuse.....	page 7	15.5 Programming the time	page 13
3.3 Refill water.....	page 7	15.6 Programming the automatic switch-on time ..	page 14
4. Commissioning.....	page 7	15.7 Programming the automatic switch-off time ..	page 15
5. Adjustment of water hardness.....	page 7	15.8 Cup counter.....	page 15
6. Installation of Claris plus filter cartridges	page 8	15.9 Number of de-scaling operations.....	page 16
6.1 Installing the filter.....	page 8	15.10 Programming the language	page 16
6.2 Replacing the filter	page 9	16. Maintenance.....	page 16
7. Rinsing the coffee machine.....	page 9	16.1 Refilling water.....	page 16
8. Drawing off espresso	page 10	16.2 Emptying the tray.....	page 17
9. Drawing off hot water.....	page 10	16.3 Replacing the filter	page 17
10. Drawing off steam	page 11	16.4 Unit calcified.....	page 17
11. Returning to Coffee Ready	page 11	16.5 General cleaning instructions	page 17
12. Professional Cappuccino Frother (optional N90).....	page 11	17. De-scaling.....	page 17
12.1 Drawing off hot milk using the Professional Cappuccino Frother	page 11	18. Disposal	page 19
12.2 Drawing off cappuccino using the Professional Cappuccino Frother	page 12	19. Tips for perfect coffee.....	page 19
12.3 Cleaning the Professional Cappuccino Frother	page 12	20. Messages.....	page 20
		21. Problems	page 21
		22. Legal information	page 22
		23. Technical Data.....	page 22

Important information

Thank you very much for purchasing this NESPRESSO coffee machine.

Before using your new machine for the first time, carefully read this operating manual and keep it for future reference.

Should you need more information or if you meet with particular problems not specified in these operating instructions in sufficient detail, either contact us directly or contact your local authorized dealer.



You will also find useful tips on operation and maintenance of your NESPRESSO N90/N9 on the website at www.jura.com

Don't forget to check out the Knowledge Builder our animated operating instructions. LEO, our assistant, will take you through all the functions.

1. Description of the machine

The JURA NESPRESSO N90/N9 was specially developed for the large number of coffee enthusiasts customers who prefer the strong flavour of a perfect espresso. The machine distinguishes itself by its elegant design and its compact dimensions. Its sophisticated and innovative design ensures an easy use: You can program the water quantity individually and make your espresso at the push of a button. This and the proven dialog system are just some of the advantages of this machine. The interaction between the aroma capsule and the machine ensure extraordinary espresso flavour cup after cup.

2. Safety information



2.1 Warning

- Children do not realize the dangers involved in using electric appliances, for this reason always keep an eye on children when they use electric appliances.
- The machine may only be used by instructed persons.
- Never use a defective machine or a machine with a defective mains cable.
- Never immerse the machine in water.

2.2 Precautions

- Never expose the machine to weather (rain, snow, frost), never touch the machine when your hands are wet.
- Place the IMPRESSA on a firm, level base that is resistant to any water that may leak. Never stand on hot or warm surfaces (oven hobs). Keep out of the reach of children.
- If you don't use the machine for a longer time (holidays, etc.) always disconnect the mains cable.
- Always disconnect mains cable before cleaning the machine.
- When disconnecting the mains cable never pull on the mains cable or the machine itself.
- Never repair or open the coffee machine yourself.
- Any repairs may only be carried out by authorized service shops using original spare parts and accessories.
- The machine is connected to mains supply via a mains cable. Make sure nobody can trip over the mains cable to prevent injuries and protect the machine against damage. Make sure children and pets cannot reach the machine
- Never put the machine or individual parts of it into a dishwasher.
- Make sure to install the machine at a place with sufficient air circulation, to prevent overheating of the machine.

2.3 Power switch

-  Actuate the power switch (18) on your NESPRESSO N90/N9 before using the machine for the first time.
-  We recommend that you switch off your NESPRESSO N90/N9 with the power switch (18) if you intend not to use the machine for longer periods of time (e.g. during holidays)
-  To ensure perfect operation, please switch the ON/OFF key on your NESPRESSO N90/N9 to standby mode. Then switch the machine off with the power switch (18).

3. First steps

3.1 Check the mains voltage

The machine is preset in the factory to the correct mains voltage. Check if your local mains supply voltage complies with the information given on the type plate on the underside of the machine.

3.2 Check electrical fuse

The machine is designed for an electric current of 10 Ampères. Check if the electrical fuse has sufficient capacity.

3.3 Refill water

-  Only use fresh, cold water. Never fill in milk, mineral water or other liquids.
- Take out the water tank and thoroughly rinse it with cold tap water (Fig. 1)
- Then, fill the water tank and reinstall it. Make sure the tank is installed correctly and that it engages properly.

4. Commissioning

- Fill the water tank.
- Use the ON/OFF key to switch on the machine.
- **DISPLAY** SPRACHE / DEUTSCH
- Now, use the arrow keys to select the required language.
- **DISPLAY** LANGUAGE / ENGLISH
- Finally, press the programming key to save the language settings.
- **DISPLAY** FILL SYSTEM – PRESS P
- Press programming key.
- **DISPLAY** SYSTEM FILLING
- **DISPLAY** MACHINE HEATING
- **DISPLAY** RINSE – PRESS DRAW-OFF KEY
- Place a cup under the coffee spout and press one of the draw-off keys (SMALLCUP or LARGECUP).
- **DISPLAY** RINSING
- **DISPLAY** READY

5. Adjustment of water hardness

-  In the machine water is heated up. As a result, calcification occurs during normal use and is indicated automatically. Before using the machine for the first time the hardness of the water used must be adjusted. Use the supplied test sticks for this.

-  1° German hardness is equivalent to 1.79° French hardness.

The machine has 5 hardness degrees which can be used and are displayed while you are adjusting the water hardness.

The displayed information means the following:

WATER

HARDNESS — Water hardness function switched off

WATER German water hardness degree 1 to 7°

HARDNESS 1 French Water hardness degree 1.79 – 12.53°

WATER German water hardness degree 8 to 15°

HARDNESS 2 French Water hardness degree 14.32 – 26.85°

WATER German water hardness degree 16 to 23°

HARDNESS 3 French Water hardness degree 28.64 – 41.17°

WATER German water hardness degree 24 to 30°

HARDNESS 4 French Water hardness degree 42.96 – 53.7°

When the machine leaves the factory it is adjusted to Level 3. You can adjust another hardness. To do this, proceed as follows:

- Use the ON/OFF key to switch on the machine.
- **DISPLAY** MACHINE HEATING
- **DISPLAY** RINSE – **PRESS DRAW-OFF KEY**
- Place a cup under the coffee spout and press one of the draw-off keys (SMALLCUP or LARGECUP).
- **DISPLAY** RINSING
- **DISPLAY** READY
- Press the programming key until the machine switches over to programming mode.
- **DISPLAY** FILTER
- Press the arrow keys a number of times until the following message appears:
 - **DISPLAY** HARDNESS
- Press the programming key to activate the programming step.
 - **DISPLAY** LEVEL 3
- Now, use the arrow keys to select the required hardness.
 - **DISPLAY** LEVEL 4

- Press programming key to confirm your settings.
 - **DISPLAY** HARDNESS
- Press the arrow keys a number of times until the following message appears:
 - **DISPLAY** EXIT
- Press the programming key to quit the programming mode.
 - **DISPLAY** READY

 If you use a Claris plus filter cartridge, this function is no longer available.

6. Installation of Claris plus filter cartridges



 If the Claris plus filter cartridge is installed properly, de-scaling of the machine is no longer required. For more information on the Claris plus filter cartridge refer to brochure «Claris plus». Hard on limescale. Gentle on your coffee machine.»

 If you do not use the Claris plus filter cartridge, the machine must be de-scaled manually. A message requesting you to replace the filter will appear on the display

 For more information on de-scaling refer to Chapter 17. Should you have any further questions, please get in touch with the responsible after-sales hotline which has been set up for you.
For the hotline telephone numbers, refer to last page.

6.1 Installing the filter

- Use the ON/OFF key to switch on the machine.
- **DISPLAY** MACHINE HEATING
- **DISPLAY** RINSE – **PRESS DRAW-OFF KEY**
- Place a cup under the coffee spout and press one of the draw-off keys (SMALLCUP or LARGECUP).

- **DISPLAY RINSING**
 - **DISPLAY READY**
 - Remove the cartridge holder from the water tank. Carefully install the filter cartridge and the cartridge holder in the water tank.
 - Move back the cartridge holder until it engages audibly (Fig. 12).
 - Fill the water tank with cold, fresh tap water and install it again.
 - Press the programming key until the machine switches over to programming mode.
 - **DISPLAY FILTER**
 - Press the programming key to activate the programming step.
 - **DISPLAY NO**
 - Press the arrow keys a number of times until the following message appears:
 - **DISPLAY YES**
 - Press programming key to confirm your settings.
 - **DISPLAY VALVE / OPEN**
 - Place a sufficiently large container (approx. 1 litre) under the hot water jet and switch the hot water / steam valve to Hot Water / Steam (Fig. 4).
 - **DISPLAY FILTER / RINSING**
 - The water draw-off operation is stopped automatically.
 - **DISPLAY VALVE / CLOSE**
 - Turn back the hot water / steam valve to Coffee (Fig. 3).
 - **DISPLAY READY**
-  The water may be slightly coloured (not harmful).
-  Now you have activated the filter. In Programming Mode the water hardness selection function is no longer displayed.

6.2 Replacing the filter

- **DISPLAY FILTER / READY**
- Press the programming key until the machine switches over to programming mode.
- **DISPLAY FILTER**
- Press the programming key to activate the programming step.
- **DISPLAY REPLACE**
- Remove the water tank and replace the Claris plus cartridge by a new one.
- Fill the water tank with cold, fresh tap water and install it again.
- Press programming key.
- **DISPLAY VALVE / OPEN**
- Place a sufficiently large container (approx. 1 litre) under the hot water nozzle and switch the hot water / steam valve to Hot Water / Steam (Fig. 4).
- **DISPLAY FILTER / RINSING**
- The water draw-off operation is stopped automatically
- **DISPLAY VALVE / CLOSE**
- Turn back the hot water / steam valve to Coffee (Fig. 3).
- **DISPLAY READY**

 The water may be slightly coloured (not harmful).

7. Rinsing the coffee machine

-  When the machine was switched off and has cooled down in the meantime, a rinsing operation is started when the machine is switched on again.
- Use the ON/OFF key to switch on the machine.
 - **DISPLAY MACHINE HEATING**

■ **DISPLAY RINSE – PRESS DRAW-OFF KEY**

■ Place a cup under the coffee spout and press one of the draw-off keys (SMALLCUP or LARGE CUP).

■ **DISPLAY RINSING**

■ **DISPLAY READY**

8. Drawing off espresso

■ Use the ON/OFF key to switch on the machine.

■ **DISPLAY MACHINE HEATING**

■ **DISPLAY RINSE – PRESS DRAW-OFF KEY**

■ Place a cup under the coffee spout and press one of the draw-off keys (SMALLCUP or LARGE CUP).

■ **DISPLAY RINSING**

■ **DISPLAY READY**

■ Open the cover and install a capsule (Fig. 5).

■ **DISPLAY COVER / CLOSE**

■ Close the cover again.

■ **DISPLAY READY**

■ Place a cup under the coffee spout and press the required draw-off key (SMALLCUP or LARGE CUP).

■ **DISPLAY SMALLCUP or LARGE CUP**

■ Your product is being prepared.

■ **DISPLAY EJECT CAPSULE**

■ Open the cover. The capsule is ejected.

■ **DISPLAY COVER / CLOSE**

■ Close the cover again.

■ **DISPLAY READY**

 You can stop the draw-off operation at any time by pressing any key.

9. Drawing off hot water

 You can adjust the water portion individually (see Chapter 15.4). Install the hot water jet (Fig. 6) to obtain perfect water flow..

 During operation, the hot water / steam jet may heat up. However, there is no danger of burns.

 At the start of the water draw-off there can be splashing. Avoid direct contact with the skin!
Do not replace the replaceable hot water jet directly after drawing off water, because the jet is hot after the draw-off operation.

■ Use the ON/OFF key to switch on the machine.

■ **DISPLAY MACHINE HEATING**

■ **DISPLAY RINSE – PRESS DRAW-OFF KEY**

■ Place a cup under the coffee spout and press one of the draw-off keys (SMALLCUP or LARGE CUP).

■ **DISPLAY RINSING**

■ **DISPLAY READY**

■ Place a cup under the hot water jet.

■ Turn the hot water / steam valve to Hot Water / Steam (Fig. 4).

■ **DISPLAY WATER / PORTION**

■ The programmed portion is being prepared..







■ **DISPLAY VALVE /CLOSE**

■ Turn back the hot water / steam valve to Coffee (Fig. 3).

■ **DISPLAY READY**

 You can stop the water draw-off operation by turning the hot water / steam valve to Coffee (Fig. 3).

10. Drawing off steam

-  Steam can be used for heating liquids and frothing milk for cappuccino. Make sure that the steam / frothing jet (12) is pushed upwards when liquids are heated. Push down the frothing aid (Fig. 7) to froth liquids.
 -  If you do not draw off steam within 1 minute, steam draw-off mode is deactivated.
 -  During operation, the hot water / steam jet may heat up. However, there is no danger of burns.
 -  Install the steam / frothing jet (Fig.7) to obtain a perfect result.
 -  During frothing some water will escape the system before the actual steam draw-off. This does not affect the result, e.g. when frothing milk.
 -  At the start of the water draw-off there can be splashing. The steam jet becomes hot. Avoid direct contact with the skin!
- Use the ON/OFF key to switch on the machine.
 - **DISPLAY** MACHINE HEATING
 - **DISPLAY** RINSE – PRESS DRAW-OFF KEY
 - Place a cup under the coffee spout and press one of the draw-off keys (SMALLCUP or LARGECUP).
 - **DISPLAY** RINSING
 - **DISPLAY** READY
 - Press the steam draw-off key.
 - **DISPLAY** MACHINE HEATING
 - **DISPLAY** STEAM / READY
 - Immerse the frothing aid in the milk to be frothed or liquid to be heated.

- Turn the hot water / steam valve to Hot Water / Steam (Fig. 4).
- **DISPLAY** STEAM / PORTION
- Your product is being prepared.
- **DISPLAY** VALVE / CLOSE
- Turn back the hot water / steam valve to Coffee (Fig. 3).
- **DISPLAY** STEAM / READY

 You can stop the steam draw-off operation by turning the hot water / steam valve to Coffee (Fig.3).

11. Returning to Coffee Ready

- Deactivate steam draw-off mode by pressing the steam draw-off key again.
- **DISPLAY** VALVE / OPEN
- Place a cup under the steam/hot frothing jet.
- Turn the hot water / steam valve to Hot Water / Steam (Fig. 4).
- **DISPLAY** MACHINE COOLING
- **DISPLAY** VALVE / CLOSE
- Turn back the hot water / steam valve to Coffee (Fig. 3).
- **DISPLAY** READY

12. Professional Cappuccino Frother (optional N90)

12.1 Drawing off hot milk using the Professional Cappuccino Frother

- To draw off hot milk, you must activate the steam draw-off mode first (see Chapter 10 “Drawing off steam”.)
- Turn the selector valve (1) (Fig. 8) to area (3) to draw off hot milk.
- Now draw off hot milk by turning the hot water / steam valve to Hot Water / Steam (Fig. 4).

12.2 Drawing off cappuccino using the Professional Cappuccino Frother

- To draw off frothed milk, you must activate the steam draw-off mode first (see Chapter 10 “Drawing off steam”).
- Turn the selector valve (1) (Fig. 8) to area (2) to draw off frothed milk.
- Now draw off frothed milk by turning the hot water / steam valve to Hot Water / Steam (Fig. 4).
- To draw off coffee again, you must activate Coffee Ready mode first (see Chapter 11 “Returning to Coffee Ready”).
- Turn the selector switch (1) (Fig. 8) in horizontal position.

12.3 Cleaning the Professional Cappuccino Frother



Remove the Professional Cappuccino Frother. If you do not achieve optimum results, disassemble the flow controller and the selector lever (Fig. 8). Thoroughly rinse these parts with water

As soon as you have frothed enough milk, it is important to clean the Professional Cappuccino Frother. Fill water in a jug and immerse the intake-tube in the water. Now draw off steam until the water/steam mixture flowing into your cup is completely clean. Your Professional Cappuccino Frother is clean again.

13. Switching off machine

- **DISPLAY** READY
- Use the ON/OFF key to switch off the machine.

14. Adjusting the water quantity for coffee

- Use the ON/OFF key to switch on the machine.
- **DISPLAY** MACHINE HEATING

■ **DISPLAY** RINSE – PRESS DRAW-OFF KEY

- Place a cup under the coffee spout and press one of the draw-off keys (SMALLCUP or LARGECUP).

■ **DISPLAY** RINSING

■ **DISPLAY** READY

- Press the draw-off key of the product to be programmed (SMALLCUP or LARGECUP) until the following message is displayed:

■ **DISPLAY** ENOUGH / COFFEE?

- As soon as the required quantity of coffee is drawn off, press the draw-off key again.

■ **DISPLAY** READY

15. Programming

You can programme the following stages:

- Filter
- Water hardness
- Steam portion
- Water portion
- Time
- Draw offs
- No. of de-scaling operations
- Language

15.1 Programming the filter

Refer to Chapter 6 “Installing the Claris plus filter cartridge”.

15.2 Programming the water hardness

Refer to Chapter 5 «Adjusting the water hardness».

15.3 Programming the steam portion

- Use the ON/OFF key to switch on the machine.
- **DISPLAY** MACHINE HEATING
- **DISPLAY** RINSE – **PRESS DRAW-OFF KEY**
- Place a cup under the coffee spout and press one of the draw-off keys (SMALLCUP or LARGE CUP).
- **DISPLAY** RINSING
- **DISPLAY** READY
- Press the programming key until the machine switches over to programming mode.
- **DISPLAY** FILTER
- Press the arrow keys a number of times until the following message appears:
- **DISPLAY** STEAM
- Press the programming key to activate the programming step.
- **DISPLAY** 20 SEC.
- Use the arrow keys to adjust the seconds.
- Press programming key to confirm your settings.
- **DISPLAY** STEAM
- Use the arrow keys to activate the next programming level or press the arrow keys until the following message is displayed:
- **DISPLAY** EXIT
- Press the programming key to quit the programming mode.

15.4 Programming the water portion

- Use the ON/OFF key to switch on the machine.
- **DISPLAY** MACHINE HEATING
- **DISPLAY** RINSE – **PRESS DRAW-OFF KEY**
- Place a cup under the coffee spout and press one of the draw-off keys (SMALLCUP or LARGE CUP).

- **DISPLAY** RINSING
- **DISPLAY** READY
- Press the programming key until the machine switches over to programming mode.
- **DISPLAY** FILTER
- Press the arrow keys a number of times until the following message appears:
- **DISPLAY** WATER
- Press the programming key to activate the programming step.
- **DISPLAY** VALVE / OPEN
- Turn the hot water / steam valve to Hot Water / Steam (Fig. 4).
- **DISPLAY** ENOUGH / WATER?
- When the required water quantity is drawn off, turn back the hot water / steam valve to Coffee position (Fig. 3).
- **DISPLAY** WATER
- Press the arrow keys a number of times until the following message appears:
- **DISPLAY** EXIT
- Press the programming key to quit the programming mode.
- **DISPLAY** READY

15.5 Programming the time

 You must programme the time if you want to use the automatic switch-on function.

- Use the ON/OFF key to switch on the machine.
- **DISPLAY** MACHINE HEATING
- **DISPLAY** RINSE – **PRESS DRAW-OFF KEY**
- Place a cup under the coffee spout and press one of the draw-off keys (SMALLCUP or LARGE CUP).
- **DISPLAY** RINSING

- **DISPLAY** READY
- Press the programming key until the machine switches over to programming mode.
- **DISPLAY** FILTER
- Press the arrow keys a number of times until the following message appears:
- **DISPLAY** TIME
- Press the programming key to activate the programming step.
- **DISPLAY** CLOCK
- Press the programming key to activate the hour setting dialog.
- **DISPLAY** —:—
- Use the arrow keys to adjust the hours.
- Press programming key to save the hour settings and activate the minutes setting dialog.
- **DISPLAY** —:—
- Use the arrow keys to adjust the minutes, confirm your settings by pressing the programming key.
- **DISPLAY** TIME
- Press the arrow keys a number of times until the following message appears:
- **DISPLAY** EXIT
- Press the programming key to quit the programming mode.
- **DISPLAY** READY

15.6 Programming the automatic switch-on time

 Before adjusting the automatic switch-on time you must program the time (Chapter 15.5).

- Use the ON/OFF key to switch on the machine.
- **DISPLAY** MACHINE HEATING

- **DISPLAY** RINSE – PRESS DRAW-OFF KEY
- Place a cup under the coffee spout and press one of the draw-off keys (SMALLCUP or LARGE CUP).
- **DISPLAY** RINSING
- **DISPLAY** READY
- Press the programming key until the machine switches over to programming mode.
- **DISPLAY** FILTER
- Press the arrow keys a number of times until the following message appears:
- **DISPLAY** TIME
- Press the programming key to activate the programming step.
- **DISPLAY** CLOCK
- Press the arrow keys a number of times until the following message appears:
- **DISPLAY** AUTO ON
- Press the programming key to activate the hour setting dialog.
- **DISPLAY** —:—
- Use the arrow keys to adjust the hours.
- Press programming key to save the hour settings and activate the minutes setting dialog.
- **DISPLAY** —:—
- Use the arrow keys to adjust the minutes, confirm your settings by pressing the programming key.
- **DISPLAY** TIME
- Press the arrow keys a number of times until the following message appears:
- **DISPLAY** EXIT
- Press the programming key to quit the programming mode.
- **DISPLAY** READY

15.7 Programming the automatic switch-off time

 You can programme your coffee machine such that it will switch off automatically after a certain time. You can programme the switch-off time in a range between 0.5 and 8 hours, or select —:— (i.e. function switched off).

- Use the ON/OFF key to switch on the machine.
- **DISPLAY** MACHINE HEATING
- **DISPLAY** RINSE – **PRESS DRAW-OFF KEY**
- Place a cup under the coffee spout and press one of the draw-off keys (SMALLCUP or LARGE CUP).
- **DISPLAY** RINSING
- **DISPLAY** READY
- Press the programming key until the machine switches over to programming mode.
- **DISPLAY** FILTER
- Press the arrow keys a number of times until the following message appears:
- **DISPLAY** TIME
- Press the programming key to activate the programming step.
- **DISPLAY** CLOCK
- Press the arrow keys a number of times until the following message appears:
- **DISPLAY** AUTO OFF
- Press the programming key again to activate the programming dialog.
- **DISPLAY** 5 HRS
- Use the arrow keys to adjust the switch-off time, confirm your settings by pressing the programming key.
- **DISPLAY** TIME
- Press the arrow keys a number of times until the following message appears:

- **DISPLAY** EXIT
- Press the programming key to quit the programming mode.
- **DISPLAY** READY

15.8 Cup counter

- Use the ON/OFF key to switch on the machine.
- **DISPLAY** MACHINE HEATING
- **DISPLAY** RINSE – **PRESS DRAW-OFF KEY**
- Place a cup under the coffee spout and press one of the draw-off keys (SMALLCUP or LARGE CUP).
- **DISPLAY** RINSING
- **DISPLAY** READY
- Press the programming key until the machine switches over to programming mode.
- **DISPLAY** FILTER
- Press the arrow keys a number of times until the following message appears:
- **DISPLAY** DRAWOFFS
- Press the programming key to activate the programming step.
- **DISPLAY** (Total Draw-offs SMALL CUP)
- Press the draw-off keys and the corresponding number of draw-offs will be displayed.
- Press the programming key to quit the programming dialog.
- **DISPLAY** DRAWOFFS
- Press the arrow keys a number of times until the following message appears:
- **DISPLAY** EXIT
- Press the programming key to quit the programming mode.
- **DISPLAY** READY

15.9 Number of de-scaling operations

- Use the ON/OFF key to switch on the machine.
- **DISPLAY** MACHINE HEATING
- **DISPLAY** RINSE – **PRESS DRAW-OFF KEY**
- Place a cup under the coffee spout and press one of the draw-off keys (SMALLCUP or LARGE CUP).
- **DISPLAY** RINSING
- **DISPLAY** READY
- Press the programming key until the machine switches over to programming mode.
- **DISPLAY** FILTER
- Press the arrow keys a number of times until the following message appears:
 - **DISPLAY** DECALC.
- Press the programming key to activate the programming step.
- **DISPLAY** (Total number of de-scaling)
- Press the programming key to quit the programming dialog.
- **DISPLAY** DECALC.
- Press the arrow keys a number of times until the following message appears:
 - **DISPLAY** EXIT
- Press the programming key to quit the programming mode.
- **DISPLAY** READY

15.10 Programming the language

- Use the ON/OFF key to switch on the machine.
- **DISPLAY** MACHINE HEATING
- **DISPLAY** RINSE – **PRESS DRAW-OFF KEY**

- Place a cup under the coffee spout and press one of the draw-off keys (SMALLCUP or LARGE CUP).
- **DISPLAY** RINSING
- **DISPLAY** READY
- Press the programming key until the machine switches over to programming mode.
- **DISPLAY** FILTER
- Press the arrow keys a number of times until the following message appears:
 - **DISPLAY** LANGUAGE
- Press the programming key to activate the programming step.
- **DISPLAY** ENGLISH
- Use the arrow keys to adjust the language, confirm your settings by pressing the programming key.
- **DISPLAY** LANGUAGE
- Press the arrow keys a number of times until the following message appears:
 - **DISPLAY** EXIT
- Press the programming key to quit the programming mode.
- **DISPLAY** READY

16. Maintenance

16.1 Refilling water

- **DISPLAY** WATER / FILL
- If this information is displayed, drawing off products is no longer possible. Refill water as described in Chapter 3.3.
- **DISPLAY** READY

16.2 Emptying the tray

■ **DISPLAY TRAY / EMPTY**

- If this message appears on the display, you can no longer draw off espresso. You must empty the capsule container first.
- Carefully take out the drip tray and the capsule container, it is filled with water.

■ **DISPLAY NO / TRAY**

- Empty the drip tray and the capsule container and install it in the machine again.

■ **DISPLAY READY**



The yellow water level indicator appears when the drip tray is full.

16.3 Replacing the filter



After drawing off 50 litres or after 2 months, the filter cartridge will be used up. Refer to Chapter 6.2 «Replacing the filter».



If your machine is disconnected from power supply, the time is not measured. A message requesting you to replace the filter will appear on the display

16.4 Unit calcified



During operation, the machine will calcify. The degree of scaling depends on the hardness of the water in your region. The machine will inform you when de-scaling is required. You can still draw off coffee or hot water/steam. However, we recommend that you should de-scale the machine (Chapter 17) within the next few days.

■ **DISPLAY SCALED / READY**

16.5 General cleaning instructions

- Never use scrapers, abrasive cloths, sponges or caustic chemicals for cleaning.
- Clean the inside and outside of the case using a soft, moist cloth.
- Clean the replaceable hot water jet and steam/frothing jet after each use.
- After heating milk, draw off some water to clean the inside of the pivoting jet.
- Disassemble the steam/frothing jet for proper cleaning (Fig. 9).
- Clean the display dialog system / control panel with a micro-fibre cloth.
- The water tank should be rinsed daily and refilled with fresh water.



If lime-scaling forms in the tank, remove it using a commercial de-scaling agent. When de-scaling the water tank, take it out of the machine.



Remove the Claris plus filter cartridge, if applicable, before de-scaling the water tank.

17. De-scaling

The machine features an integrated de-scaling programme. The de-scaling operation will take some 40 min.



Your machine will inform you if it needs de-scaling. You can still draw off coffee or hot water / steam and start the de-scaling programme later. Switch off the system before starting the de-scaling programme. Once started, the de-scaling programme must not be interrupted.

 If applicable, remove the Professional Cappuccino Frother (optional accessories) before starting the de-scaling operation.

 If acidic de-scaling agents are used, remove any splashes and drops from sensitive surfaces, in particular surfaces made of natural stone and wood, alternatively take appropriate preventive measures.

In any case wait until the de-scaling agent is used up and the tank is empty. Never refill de-scaling agent.

■ **DISPLAY SCALED / READY**

- Use the ON/OFF key to switch off the machine.
- Take out and empty the water tank.
- Press programming key until the following message is displayed:

■ **DISPLAY TRAY / EMPTY**

- Take out tray, empty it and reinstall it.

■ **DISPLAY FILL IN AGENT – PRESS P**

JURA de-scaling tablets

Completely dissolve the content of one blister (3 tablets) in a jug containing 0.5 liters of water, and fill the mixture in the water tank.

or

NESPRESSO De-scaling Kit

Dissolve 1 pack of de-scaling agent in 0.5 litres of water and fill the mixture in the water tank.

- Reinstall the water tank.

- Press programming key.

■ **DISPLAY VALVE / OPEN**

- Put a sufficiently large container under the hot water jet
- Turn the hot water / steam valve to Hot Water / Steam (Fig.4).

■ **DISPLAY MACHINE / DECALC.**

■ **DISPLAY VALVE / CLOSE**

- Turn back the hot water / steam valve to Coffee (Fig. 3).

■ **DISPLAY MACHINE / DECALC.**

■ **DISPLAY VALVE / OPEN**

- Turn the hot water / steam valve to Hot Water / Steam (Fig. 4).

■ **DISPLAY MACHINE / DECALC.**

■ **DISPLAY EMPTY / TRAY**

- Take out tray, empty it and reinstall it.

■ **DISPLAY FILL / WATER**

 Thoroughly rinse the water tank and fill it with fresh cold tap water. Then reinstall it.

■ **DISPLAY P-TASTE**

- Press programming key.

■ **DISPLAY MACHINE / DECALC.**

■ **DISPLAY VALVE / CLOSE**

- Turn back the hot water / steam valve to Coffee (Fig. 3).

■ **DISPLAY MACHINE / DECALC.**

■ **DISPLAY TRAY / EMPTY**

- Take out tray, empty it and reinstall it.

■ **DISPLAY READY**

- The machine will be switched off automatically after a few seconds.

 After the de-scaling, clean the aluminium front using a slightly moist cloth.

18. Disposal

Please return the machine to your local dealer, the service shop or to JURA for proper disposal.

19. Tips for perfect coffee

Preheating cups

You can preheat the cups using hot water or steam. The smaller the coffee you want to draw off, the more important preheating is

Sugar and cream

Stirring coffee/tea will result in heat being released. Adding refrigerated cream or milk will reduce the temperature of the coffee significantly.

20. Messages

DISPLAY	Cause	Remedy
WATER / REFILL	Water tank is empty. Water level indicator jammed Tank calcified; water level-indicator jammed	Refill water Empty tank, rinse and install again Remove tank, de-scale, rinse thoroughly, fill and install it again
TRAY / EMPTY	Capsule container full Message does not disappear after the tank was emptied	Take out drip tray and capsule container, Empty container and tray and install it again Container was removed for less than 8 sec. Take out tray for approx. 10 sec. and install it again.
TRAY / NO	Tray not engaged properly	Install tray correctly
VALVE / OPEN	Temperature is above the coffee temperature	Machine must be allowed to cool down to coffee temp. → Open valve (see Chapter 11)
READY / CALCIFIED	Machine must be de-scaled	Carry out de-scaling operation according to Chapter 16
READY / FILTER	Filter is used up and must be replaced	Replace filter according to Chapter 6.2

21. Problems

Problem	Cause	Remedy
Coffee only drips from the coffee spout	Pyramid plate soiled by coffee powder residues	Start draw-off operation without capsule (rinse)
Coffee temperature too low	Machine calcified	De-scale according to Chapter 17
	first coffee draw-off operation after cold start	Program automatic switch-on time of machine
Not enough froth while frothing up milk	Frothing aid blocked	Clean frothing aid (Chapter 16.5)
	Frothing aid in wrong position	Draw off steam (Chapter 10)

If the messages or problems are still present, please contact your local authorized dealer or JURA Elektroapparate AG.

22. Legal information

These operating instructions contain all the information required for using, operating and maintaining the machine properly.

Knowledge of and compliance with the specifications contained in these operating instructions is required for using the machine safely as well as for operational safety and safety during maintenance. These operating instructions cannot cover any conceivable application. The machine was designed for private household use.

Additionally we point out that the content of these operating instructions does not form part of any previous or existing agreement, consent or a legal relationship nor does it constitute a change of such a(n) agreement, consent or legal relationship. Any obligations to be fulfilled by JURA Elektroapparate AG are stipulated in the corresponding purchase contract, which also contains the full and solely applicable warranty stipulations. These contractual warranty stipulations are neither extended nor limited by the specifications contained in these operating instructions.

The operating instructions contain information, protected by Copyright. Photocopying or translations into other languages shall not be permissible without JURA Elektroapparate AG's written approval.

23. Technical Data

Voltage:	230V AC
Power:	1265 W
Fuse:	10 A
Safety check:	
Energy consumption Standby:	approx.1.2 Wh
Energy consumption «Ready for draw-off»:	approx. 28 Wh
Pump pressure:	static max. 19 bar
Water tank:	1.4 l
Capacity of capsule container:	14 capsules
Length of mains cable:	approx.1.1 m
Weight:	6.4 kg
Dimensions (WxHxD):	25 x 29.5 x 39.5

The machine complies with the following directives:

72/23/EEG dated 19/02/1973 "Low Voltage Directive" including Modification Directive 93/336/EEG

89/336/EEG dated 03/05/1989 "EMC Directive" including Modification Directive 92/31/EEG