

*jura*®



## J6 Instructions for Use



For your safety: read and understand manual before use.

# Your J6

|   |           |
|---|-----------|
| <b>IMPORTANT SAFEGUARDS</b>   | <b>4</b>  |
| <b>Control elements</b>   | <b>8</b>  |
| <b>1 Preparing and using for the first time</b>                         | <b>10</b> |
| JURA on the Internet.....   | 10        |
| Setting up the machine.....   | 10        |
| Filling the bean container.....   | 10        |
| Determining the water hardness.....                                     | 10        |
| First-time use.....   | 11        |
| Connecting milk.....  | 14        |
| <b>2 Preparation</b>  | <b>15</b> |
| Ways of preparing a beverage.....                                       | 16        |
| Ristretto, espresso and coffee.....                                     | 17        |
| Two ristretti, two espressi and two coffees.....                        | 17        |
| Latte macchiato, cappuccino and other specialty coffees with milk.....  | 17        |
| Ground coffee.....  | 18        |
| Permanently setting the amount of water for the cup size.....           | 19        |
| Adjusting the grinder.....  | 19        |
| Hot water.....  | 20        |
| <b>3 Daily operation</b>  | <b>21</b> |
| Filling the water tank.....   | 21        |
| Switching on the machine.....   | 21        |
| Daily maintenance.....  | 22        |
| Regular maintenance.....  | 22        |
| Switching off the machine.....  | 23        |
| <b>4 Permanent settings in programming mode</b>                         | <b>24</b> |
| Adjusting the product settings.....                                     | 25        |
| Adding products to the start screen, duplicating and personalizing..... | 27        |
| Automatic switch-off.....   | 28        |
| Energy-saving mode.....   | 28        |
| Setting the water hardness.....   | 29        |
| Display settings.....   | 29        |
| Unit for amount of water.....   | 30        |
| Restore factory settings.....   | 30        |
| Language.....   | 31        |
| Querying information.....   | 31        |
| <b>5 Maintenance</b>  | <b>33</b> |
| Rinsing the machine.....  | 34        |
| Automatic milk system rinsing.....                                      | 34        |
| Cleaning the milk system.....   | 34        |
| Dismantling and rinsing the cappuccino frother.....                     | 36        |
| Inserting the filter.....   | 36        |
| Changing the filter.....  | 37        |

|  |           |
|--|-----------|
| Cleaning the machine .....                               | 38        |
| Descaling the machine.....                               | 40        |
| Cleaning the bean container.....                         | 42        |
| Descaling the water tank .....                           | 42        |
| <b>6 Display messages</b>                                | <b>43</b> |
| <b>7 Troubleshooting</b>                                 | <b>44</b> |
| <b>8 Transport and environmentally friendly disposal</b> | <b>46</b> |
| Transport / Emptying the system.....                     | 46        |
| Disposal.....  | 46        |
| <b>9 Technical data</b>                                  | <b>47</b> |
| <b>10 Index</b>  | <b>48</b> |
| <b>11 JURA contact details / Legal information</b>       | <b>52</b> |

## Symbol description

### Warnings



This is the safety alert symbol. It is used to alert you to potential personal injury hazards. Obey all safety messages that follow this symbol to avoid possible injury or death.

#### DANGER

DANGER indicates a hazardous situation which, if not avoided, will result in death or serious injury.

#### WARNING

WARNING indicates a hazardous situation which, if not avoided, could result in death or serious injury.

#### CAUTION

CAUTION, used with the safety alert symbol, indicates a hazardous situation which, if not avoided, could result in minor or moderate injury.

#### NOTICE

NOTICE is used to address practices not related to personal injury.

### Symbols used

- ▶ **Prompt to take action.** This symbol means that you are being prompted to perform some action.

**i** **Information** and tips to make it even easier to use your J6.

'Coffee' **Display message**

## IMPORTANT SAFEGUARDS

**Follow the basic safety precautions**

When using electrical appliances, basic safety precautions shall always be followed, to reduce the risk of fire, electric shock, and/or injury to persons, including the following:

- Read all instructions.
- Do not touch hot surfaces. Use handles or knobs.
- To protect against fire, electric shock and injury to persons, do not immerse power cord, plugs, or body of machine in water or other liquid.
- Close supervision is necessary when any appliance is used by or near children.
- Unplug from outlet when not in use and before cleaning. Allow to cool before putting on or taking off parts, and before cleaning the appliance.
- Do not operate any appliance with a damaged cord or plug or after the appliance malfunctions, or has been damaged in any manner. Return appliance to the nearest authorized service facility for examination, repair or adjustment.
- The use of an accessory attachment not recommended by the appliance manufacturer may result in fire, electric shock, or injury to persons.
- Do not use outdoors.
- Do not let the cord hang over the edge of a table or counter, or touch hot surfaces.
- Do not place on or near a hot gas or electric burner, or in a heated oven.
- To disconnect, turn any control to 'OFF' then remove plug from wall outlet.
- Do not use appliance for other than intended use.
- Use extreme caution when dispensing hot steam, hot water or hot coffee.
- For household use only.

**SAVE THESE INSTRUCTIONS.**

Pass them on to any subsequent user.

**Intended use** The appliance is designed and intended for household use only. It shall only be used for coffee preparation and to heat milk and water, according to these instructions. Use for any other purpose will be deemed improper. JURA Elektroapparate AG cannot accept any responsibility for the consequences of improper use.

People, including children, who

- do not have the physical, sensory or mental capabilities to use the appliance safely or
- are inexperienced or lack knowledge in how to use the appliance safely

must be supervised by a responsible person when using it, or must be instructed in how to use it correctly.

**Special power cord set instructions**

- A short power-supply cord is to be provided to reduce risks resulting from becoming entangled in or tripping over a longer cord.
- The cord shall be arranged so that it will not drape over the counter top or table top where it can be pulled on by children or tripped over.
- This appliance has a 3-pin grounded plug.
- Do not modify the plug in any way.

Extension cords are available and may be used if care is exercised in their use.

If the user chooses to use an extension cord,

- the marked electrical rating of the extension cord should be at least as great as the electrical rating of the appliance, and
- if the appliance is of the grounded type, the extension cord should be a grounding type 3-wire cord, and
- the longer cord should be arranged so that it will not drape over the counter top or tabletop where it can be pulled on by children or tripped over.

** WARNING**



To reduce the risk of fire or electric shock, DO NOT remove any service covers. DO NOT modify the appliance in any way that is not described in these instructions. NO user serviceable parts included. Repair MUST be done by authorized personnel only.

In the event of signs of damage, for example if there is a smell of burning, unplug the machine immediately from outlet and contact JURA customer service.

## IMPORTANT SAFEGUARDS

### **⚠ CAUTION**

This appliance is for household use. Any servicing other than cleaning and user maintenance shall be performed by an authorized service representative:

- Do not immerse base in water or try to disassemble.
- Do not put the appliance or any individual parts in the dishwasher.
- Check voltage to be sure that the voltage indicated on the name plate complies with your voltage. The name plate is located on the underside of the appliance.
- Never use warm or hot water to fill the water container. Use cold water only.
- Keep your hands and the cord away from hot parts of the appliance during operation.

There is a risk of scalds or burns on the spouts and the cappuccino frother / nozzle.

- Keep children away.
- Do not touch any hot parts. Use the handles or knobs provided.
- Ensure that the cappuccino frother / nozzle is correctly fitted and clean. If incorrectly fitted or if they become blocked, the cappuccino frother or its parts might come off.
- Never clean with scouring powders or hard implements.
- Ensure that the ventilation slots are not covered.
- Never pull out the drip tray during the brewing process. Only pull the drip tray when the display instructs you or when the appliance is ready for use.

### **NOTICE**



**NEVER DO**  
**(or you will void your**  
**warranty protection):**

- Never fill instant coffee, chocolate mix etc. into the bean container or ground coffee funnel (filler funnel for ground coffee). It will damage the functioning of the brewing chamber.
- Never fill sugar coated coffee beans into the bean container. In case of doubt, call your dealer.
- Never fill anything other than coffee beans into the bean container (no chocolate, no rice, no nuts, no spices, nothing other than roasted coffee beans).
- Never fill frozen beans into the bean container. If you store beans in the freezer, let them thaw 3 to 4 hours before filling them into the bean container.
- Never fill anything but fresh, cold and clean water into the water tank, except when decalcifying.
- Never use mineral or carbonated water. You can use tap water, bottled water, spring water and reverse osmosis water.
- Never do anything with the machine which is not described in these instructions. In case of doubt, call your dealer.

Control elements

# Control elements

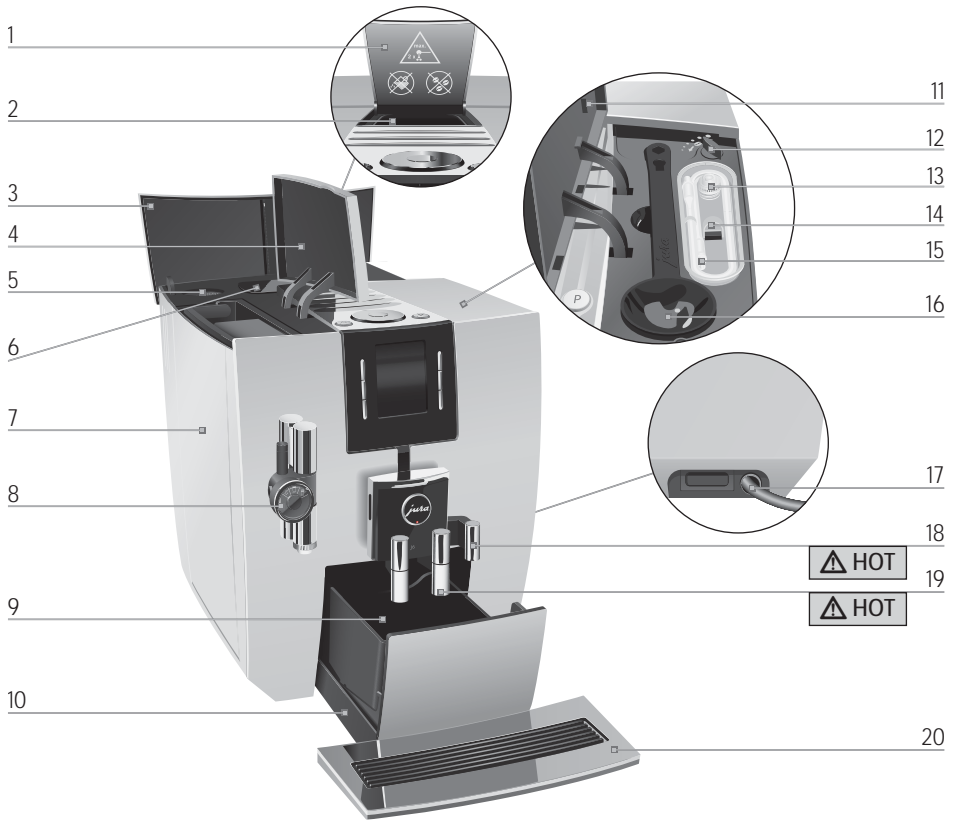

- |    |  |    |   |
|----|--|----|---|
| 1  | Filler funnel cover                          | 11 | Storage compartment cover                 |
| 2  | Filler funnel for ground coffee              | 12 | Grinder adjustment switch                 |
| 3  | Bean container cover                         | 13 | Interchangeable milk spout                |
| 4  | Water tank cover                             | 14 | Storage compartment insert                |
| 5  | Service socket                               | 15 | Milk pipe                                 |
| 6  | Bean container with aroma preservation cover | 16 | Measuring spoon for ground coffee         |
| 7  | Water tank                                   | 17 | Power cord (side of machine)              |
| 8  | Height-adjustable cappuccino frother         | 18 | Hot-water spout                           |
| 9  | Coffee grounds container                     | 19 | Height- and width-adjustable coffee spout |
| 10 | Drip tray                                    | 20 | Cup platform                              |



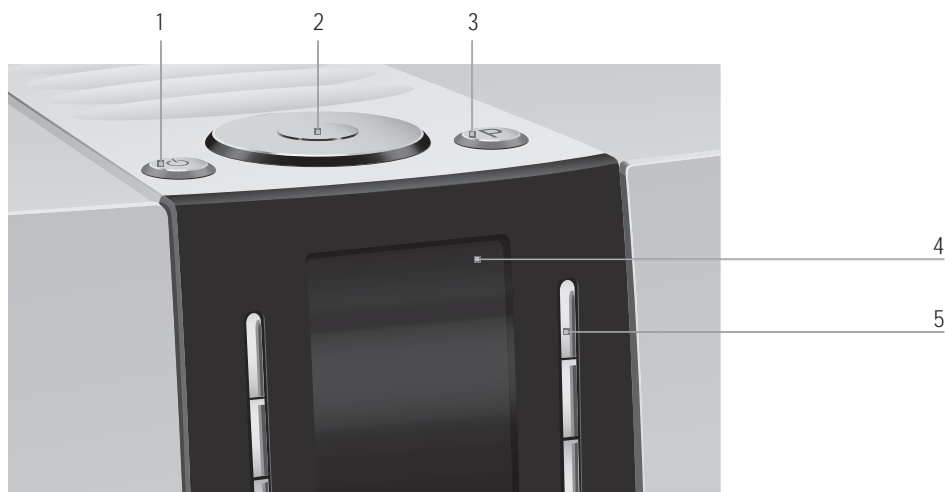

#### Top of the machine

- 1 On/Off button 
- 2 Rotary Switch
- 3 P button (programming)

#### Front

- 4 Display
- 5 Multi-function buttons (button function depends on what is shown in the display)

#### Container for milk system cleaning



## 1 Preparing and using for the first time

### JURA on the Internet

Visit us on the Internet ([www.jura.com](http://www.jura.com)). You will find interesting and up-to-date information on your J6 and on every aspect of coffee.

### Setting up the machine

When setting up your J6, please note the following:

- Place the J6 on a horizontal surface that is not sensitive to water.
- Choose a spot for your J6 which protects the machine against overheating. Ensure that the ventilation slots are not covered.



### Filling the bean container

The bean container has an aroma preservation cover. This will ensure that your coffee beans retain their aroma for longer.

#### NOTICE

Coffee beans which have been treated with additives (e.g. sugar), ground coffee or freeze-dried coffee will damage the grinder.

- ▶ Only use roasted, untreated coffee beans to fill the bean container.
- 
- ▶ Open the bean container cover and remove the aroma preservation cover.
  - ▶ Remove any dirt or foreign objects from inside the bean container.
  - ▶ Fill the bean container with coffee beans, then close the aroma preservation cover and the bean container cover.

### Determining the water hardness

When you use the machine for the first time, you must set the water hardness. If you do not know the hardness of your water, you can find this out first. Use the Aquadur® test strips supplied with the machine.

- ▶ Hold the test strip briefly (for 1 second) under flowing water. Shake off the water.
- ▶ Wait for about 1 minute.

- ▶ You will then be able to read the degree of water hardness from the discoloration of the Aquadur® test strip and the description on the packaging.

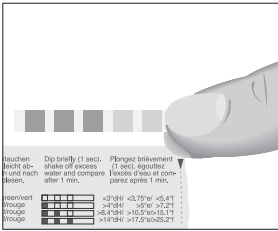

| Level           | Display German Degree (°dH) | Degrees of general hardness (°dGH) | Parts per million (ppm) | Indicator Strip number of 'reddish' fields |
|-----------------|-----------------------------|------------------------------------|-------------------------|--|
| Not active      | -                           | -                                  | -                       | -  |
| Very soft water | <3                          | <3                                 | < 53.4                  | None                                       |
| Soft water      | > 4                         | > 4                                | > 71                    | 1  |
| Hard water      | > 8.4                       | > 8.4                              | > 150                   | 2  |
| Very hard water | > 14                        | > 14                               | > 250                   | 3  |

## First-time use

When using the machine for the first time, you can choose whether you want to operate J6 **with** or **without** the CLEARLY Smart filter cartridge. As well as limescale, the filter cartridge filters many other substances that impair aroma and flavour out of the water. These substances may negatively affect the coffee. To enjoy the best quality coffee at all times, we recommend that you use CLEARLY Smart.

### WARNING

If the machine is operated with a defective power cord, there is a danger of potentially fatal electric shock.

- ▶ Never use a machine which is damaged.
- ▶ Never use a machine which has a defective power cord.

**i** The water volume is given as standard in 'oz'. You can change this setting to 'ml' in programming mode (see Chapter 4 'Permanent settings in programming mode – Unit for amount of water').

**Precondition:** The bean container has been filled.

- ▶ Insert the mains plug into a power socket.
  - ▶ Press the On/Off button to switch the J6 on.
- 'Choose language' / 'English'

**i** To view more languages, turn the Rotary Switch.

## 1 Preparing and using for the first time

- ▶ Press the 'Save' button.  
'Saved' appears briefly on the display to confirm the setting.  
'Water hardness'

**i** If you do not know the hardness of your water, you must find this out first (see Chapter 1 'Preparing and using for the first time – Determining the water hardness').

- ▶ Turn the Rotary Switch to change the water hardness setting, e.g. to '25 °dH'.
- ▶ Press the 'Save' button.  
'Saved' appears briefly on the display.  
'Insert filter'

**i** Now decide whether you want to operate your J6 **with** or **without** a CLEARYL Smart filter cartridge.

Operation **with** filter cartridge: go straight to the next section.

Operation **without** filter cartridge: see Chapter 1 'Preparing and using for the first time – First-time use without filter cartridge activation'.

### First-time use with filter cartridge activation

#### NOTICE

Milk, sparkling mineral water or other liquids can damage the water tank or the machine.

- ▶ Only fill the water tank with fresh, cold water.



- ▶ Place one receptacle under the hot-water spout and another under the cappuccino frother.
- ▶ Remove the water tank and rinse it with cold water.
- ▶ Open the filter holder.
- ▶ Fit the filter cartridge extension supplied on top of a CLEARYL Smart filter cartridge .



- ▶ Insert the filter cartridge with its extension into the water tank.
- ▶ Close the filter holder. It will click into place audibly.
- ▶ Fill the water tank with fresh, cold water and reinsert the tank.

**i** The machine automatically detects that you have just inserted the filter cartridge.

*'Filter operation' / 'Saved'*

*'Filter is being rinsed'*, water flows out of the hot-water spout.

Rinsing of the filter stops automatically after approximately 10 oz (300 ml).

*'System is filling'*, water flows out of the cappuccino frother.

*'Empty drip tray'*

- ▶ Empty the drip tray and put it back into the machine.
- ▶ Place a receptacle under the coffee spout.

*'Machine is heating'*

*'Machine is rinsing'*, the system is rinsed. The rinse stops automatically. *'Please select product'* appears on the display. Your J6 is ready for use.

**i** The display shows the products you can prepare.

**i** If the filter is active, this is indicated by a blue filter symbol in the top right of the display.

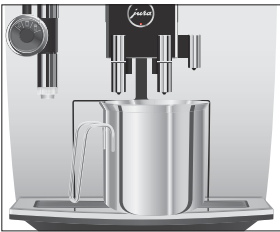

### First-time use without filter cartridge activation

---

#### NOTICE

Milk, sparkling mineral water or other liquids can damage the water tank or the machine.

- ▶ Only fill the water tank with fresh, cold water.
- 

- ▶ Press the *'No filter'* button.

*'Descaling mode' / 'Saved'*

*'Fill water tank'*

## 1 Preparing and using for the first time



- ▶ Place a receptacle under the cappuccino frother, the coffee spout and the hot-water spout.



- ▶ Remove the water tank and rinse it with cold water.
- ▶ Fill the water tank with fresh, cold water and reinsert the tank.
  - 'System is filling', the system fills up with water.
  - 'Machine is heating'
  - 'Machine is rinsing', water flows out of the coffee spout. The rinse stops automatically. Your J6 is ready for use.

**i** The display shows the products you can prepare.

## Connecting milk

Your J6 creates fine, creamy, feather-light milk foam with a perfect consistency. The most important requirement for frothing milk is a milk temperature of 39–46 °F (4–8 °C). We would therefore recommend using a milk cooler or a milk container.

**i** Suitable milk containers from JURA are available from specialized dealers.

- ▶ Remove the protective cover from the cappuccino frother.

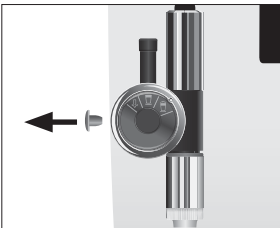

- ▶ Attach the milk pipe to the cappuccino frother.
- ▶ Connect the other end of the milk pipe to a milk container or a milk cooler.

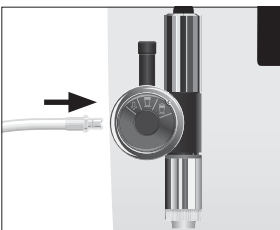

## 2 Preparation

### WARNING

Hot coffee, hot steam and hot water can cause scalding. Scalding is a serious burn.

- ▶ Use extreme care when handling hot liquid or steam.
- ▶ Allow liquid to cool down before drinking.
- ▶ In the event of scalding, rinse affected area with cold water and seek medical attention.
- ▶ Keep children AWAY.

### Basic information about preparing drinks:

- During the grinding operation you can select the coffee strength of **single products** by turning the Rotary Switch.
- During preparation, you can change the preset **amounts** (e.g. amount of water or milk) by turning the Rotary Switch.
- You can stop the machine at any time while a specialty coffee or hot water is being prepared. To do this, press the ‘’ button or the Rotary Switch.

**i** The water volume is given as standard in ‘oz’. You can change this setting to ‘ml’ in programming mode (see Chapter 4 ‘Permanent settings in programming mode – Unit for amount of water’).

Coffee tastes best served hot. A cold porcelain cup cools the beverage – and impairs the taste. We therefore recommend prewarming the cups. The full coffee aroma can develop only in prewarmed cups. You can purchase a JURA cup warmer from your specialized dealer.

You can make **permanent settings** for all products in programming mode (see Chapter 4 ‘Permanent settings in programming mode – Adjusting the product settings’).

## Ways of preparing a beverage

The J6 offers various ways of preparing a specialty coffee, milk or hot water:

- **Preparation using the start screen:** Simply press the corresponding preparation button for the product shown on the display (start screen) that you want.

The following products are displayed as standard:

- ‘Cappuccino’
- ‘Latte macchiato’
- ‘1 portion milk’
- ‘Espresso’
- ‘Coffee’
- ‘Hot water’

- **Using the product selector view (Rotary Selection):** Only some of the products you can prepare are shown on the start screen. As soon as you turn the Rotary Switch, more products are displayed in a **product selector view**.

Turn the Rotary Switch to bring the product you want into focus. Start preparation by pressing the Rotary Switch.

The following additional products are shown in the product selector view:

- ‘Ristretto’
- ‘Flat White’
- ‘Macchiato’

**i** The product selector view disappears automatically after 10 seconds if no preparation is started.

**i** You can move any of the standard products programmed in your J6 to your preferred position on the start screen or in the product selector and make it one of your favorites. You can duplicate and personalize your favorite specialty coffees by giving them a new product name and individual settings (e.g. amount and coffee strength) (see Chapter 4 ‘Permanent settings in programming mode – Adding products to the start screen, duplicating and personalising’). Please note that the descriptions provided in the following sections always refer to the default settings.



## Ristretto, espresso and coffee



**Example:** Proceed as follows to prepare one coffee.

- ▶ Place a cup under the coffee spout.
- ▶ Press the **'Coffee'** button.

Preparation starts. **'Coffee'** and the coffee strength are displayed. The preset amount of water for coffee flows into the cup.

Preparation stops automatically. Your J6 is once more ready for use.

## Two ristretti, two espressi and two coffees

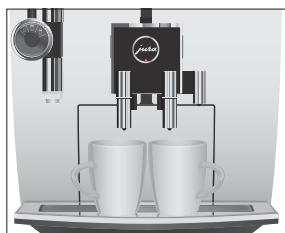

To prepare **two** specialty coffees, press the appropriate preparation button twice (within approximately 2 seconds).

**Example:** Proceed as follows to prepare two espressi.

- ▶ Place two cups under the coffee spout.
- ▶ Press the **'Espresso'** button **twice (within 2 seconds)** to start preparation.

**'2 x Espresso'** appears and the preset amount of water flows into the cups.

Preparation stops automatically. Your J6 is once more ready for use.

## Latte macchiato, cappuccino and other specialty coffees with milk



Your J6 prepares latte macchiato, cappuccino, flat white and espresso macchiato at the touch of a button. There is no need to move the glass or cup.

**Example:** Proceed as follows to prepare one latte macchiato.

- ▶ Place a glass under the cappuccino frother.
- ▶ Turn the setting wheel of the cappuccino frother to the Milk Foam area .
- ▶ Press the **'Latte macchiato'** button.

**'Latte macchiato'** appears and the preset amount of milk flows into the glass.

**i** There is a short interval while the hot milk separates from the milk foam. This allows the typical layers of a latte macchiato to form.

Coffee preparation starts. The preset amount of water for espresso flows into the glass. Preparation stops automatically. **'Rinse the milk system'** appears on the display.

## 2 Preparation

- i** 15 minutes after preparation, the milk system is automatically rinsed (see Chapter 5 'Maintenance – Automatic milk system rinsing'). Therefore always place a receptacle under the cappuccino frother after preparing milk.

To ensure that the cappuccino frother always works properly, you must clean it **daily** when you have been preparing milk (see Chapter 5 'Maintenance – Cleaning the milk system').

### Ground coffee

You can choose to use a second coffee variety, for example decaffeinated coffee, with the filter funnel for ground coffee.

- i** Never add more than two level measuring spoons of ground coffee.
- i** Use ground coffee which is not ground too finely. Very fine coffee can block up the system so that the coffee only comes out in drips.
- i** If you did not fill the machine with a sufficient amount of ground coffee, 'Not enough ground coffee' is displayed and the J6 stops the operation.
- i** The desired specialty coffee must be prepared within approximately one minute after filling with the ground coffee. Otherwise the J6 stops the operation and is once more ready for use.

All specialty coffees with ground coffee are always prepared following the same model.

**Example:** Proceed as follows to prepare one espresso using ground coffee.



- ▶ Place an espresso cup under the coffee spout.
- ▶ Open the powder chute cover.  
'Please add ground coffee'
- ▶ Place one level measuring spoon of ground coffee into the filler funnel.
- ▶ Close the cover of the filler funnel.  
'Please select product'
- ▶ Press the 'Espresso' button.  
Preparation starts. 'Espresso' appears and the preset amount of water for espresso flows into the cup.

Preparation stops automatically. Your J6 is once more ready for use.

## Permanently setting the amount of water for the cup size



It is easy to permanently adjust the amount of water for all **single products** to the cup size. Adjust the amount once as shown in the following example. Every time you prepare a drink in the future, this amount will be dispensed.

**Example:** Proceed as follows to **permanently** set the amount of water for one coffee.

- ▶ Place a cup under the coffee spout.
  - ▶ Press and **hold** the 'Coffee' button until 'Enough coffee? Press button' appears.
  - ▶ Release the 'Coffee' button.
- Preparation starts and the coffee flows into the cup.
- ▶ Press any button as soon as there is sufficient coffee in the cup.

Preparation stops. 'Saved' appears briefly on the display. The set amount of water for one coffee is permanently stored. Your J6 is once more ready for use.

- i** You can alter this setting at any time by repeating the above procedure.
- i** You can also permanently set the amounts for all single products in programming mode (see Chapter 4 'Permanent settings in programming mode – Adjusting the product settings').

## Adjusting the grinder

You can adjust the grinder to suit the degree of roast of your coffee.

### NOTICE

If you adjust the consistency of grind when the grinder is not operating, the grinder adjustment switch could be damaged.

- ▶ Only adjust the consistency of grind when the grinder is running.

The consistency of grind is correct if the coffee flows regularly from the coffee spout. In addition a fine, thick crema forms.

**Example:** Proceed as follows to change the consistency of grind **during** the preparation of an espresso.

## 2 Preparation



- ▶ Place a cup under the coffee spout.
- ▶ Open the storage compartment cover.
- ▶ Press the 'Espresso' button to start preparation.
- ▶ Turn the grinder adjustment switch to the desired position **while** the grinder is running.  
The preset amount of water flows into the cup. Preparation stops automatically.
- ▶ Close the storage compartment cover.

## Hot water

### **⚠ CAUTION**

---

There is a danger of scalding from hot water splashes.

- ▶ Avoid direct contact with the skin.
- 



- ▶ Place a cup under the hot-water spout.
- ▶ Press the 'Hot water' button.  
'Hot water', the preset amount of water flows into the cup. Preparation stops automatically. 'Please select product' appears on the display.

## 3 Daily operation

### Filling the water tank

Daily maintenance of the machine and hygiene when handling milk, coffee and water are key to a perfect coffee result in the cup every time. You should therefore change the water **daily**.

**NOTICE** Milk, sparkling mineral water or other liquids can damage the water tank or the machine.

- ▶ Only fill the water tank with fresh, cold water.



- ▶ Open the water tank cover.
- ▶ Remove the water tank and rinse it with cold water.
- ▶ Fill the water tank with fresh, cold water and reinsert the tank.
- ▶ Close the water tank cover.

### Switching on the machine

Daily maintenance of the machine and hygiene when handling milk, coffee and water are key to a perfect coffee result in the cup every time. You should therefore change the water **daily**.



- ▶ Place a receptacle under the coffee spout.
- ▶ Press the On/Off button  to switch the J6 on.

'Welcome to JURA'

'Machine is heating'

'Machine is rinsing', the system is rinsed.

The rinse stops automatically. 'Please select product' appears on the display. Your J6 is ready for use.

## Daily maintenance

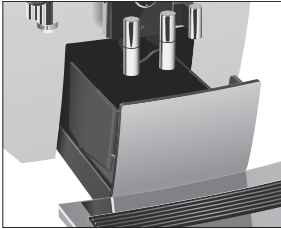

To ensure that you get many years of reliable service out of your J6 and to guarantee the optimum coffee quality, the machine requires daily maintenance.

- ▶ Pull out the drip tray.
- ▶ Empty the coffee grounds container and the drip tray. Rinse them both with warm water.

**i** Always empty the coffee grounds container when the machine is **switched on**. This is the only way of resetting the coffee grounds counter.

- ▶ Refit the coffee grounds container and the drip tray.
- ▶ Rinse the water tank with clean water.
- ▶ Clean the cappuccino frother (see Chapter 5 'Maintenance – Cleaning the milk system').
- ▶ Remove the milk pipe and rinse it thoroughly under running water.
- ▶ Dismantle and rinse the cappuccino frother (see Chapter 5 'Maintenance – Dismantling and rinsing the cappuccino frother').
- ▶ Wipe the surface of the machine with a clean, soft, damp cloth (e.g. microfiber cloth).

## Regular maintenance

Carry out the following maintenance actions **regularly** or **as required**:

- In the interests of hygiene, we recommend changing the milk pipe and interchangeable milk spout on a regular basis (approximately every 3 months). Replacements are available from specialized dealers.
- Clean the inside of the water tank, e.g. with a brush. Further information about the water tank is provided in these instructions for use (see Chapter 5 'Maintenance – Descaling the water tank').
- Traces of milk and coffee may stick to the top and bottom of the cup platform. If this happens, clean the cup platform.

## Switching off the machine



When the J6 is switched off, the system is automatically rinsed if a specialty coffee has been prepared. If milk has been prepared, you will also be prompted to clean the milk system.

- ▶ Place one receptacle under the coffee spout and another under the cappuccino frother.
- ▶ Press the On/Off button .

**i** If milk has been prepared, you will be prompted to clean the milk system ('Clean the milk system'). After 10 seconds the switch-off process continues automatically.

If milk has been prepared but you have not started milk system cleaning, the milk system is rinsed first ('Milk system is being rinsed').

'Machine is rinsing', the system rinses itself. The operation stops automatically. Your J6 is switched off.

## 4 Permanent settings in programming mode



### WARNING

Hot coffee, hot steam and hot water can cause scalding. Scalding is a serious burn.

- ▶ Use extreme care when handling hot liquid or steam.
- ▶ Allow liquid to cool down before drinking.
- ▶ In the event of scalding, rinse affected area with cold water and seek medical attention.
- ▶ Keep children AWAY.

Press the P button to enter programming mode. You can navigate through the program items and permanently save the required settings simply by turning the Rotary Switch and using the multi-function buttons. The following settings can be made:

| Program item         | Sub-item   | Explanation  |
|----------------------|--|--|
| 'Maintenance status' | 'Clean',<br>'Change the filter' (only if filter is fitted),<br>'Descale',<br>'Clean the milk system',<br>'Rinse',<br>'Maintenance information' | ▶ <b>Here you can start</b> the required maintenance program or find out what maintenance actions are required.  |
| 'Product settings'   | 'Expert mode'  | ▶ Select your settings for specialty coffees and hot water.  |
|                      | 'Classics'   | ▶ Replace the products on the start screen and in the product selector with your favorites. Duplicate and personalize your favorite specialty coffees by giving them a new product name and individual settings. |
| 'Machine settings'   | 'Choose language'  | ▶ Select your language.  |
|                      | 'Switch off after'   | ▶ Set the time after which the J6 should switch off automatically.   |
|                      | 'Save energy'  | ▶ Select an energy-saving mode.  |
|                      | 'Factory setting'  | ▶ Reset the machine to its factory setting.  |
|                      | 'Units'  | ▶ Select the unit for the amount of water.   |
|                      | 'Display'  | ▶ Change the display settings.   |



| Program item | Sub-item                                    | Explanation  |
|--------------|---|--|
|              | 'Water hardness'                            | ► Adjust the water hardness.   |
|              | 'Product counter',<br>'Maintenance counter' | ► Keep track of all products prepared and view the number of maintenance programs performed. |
|              | 'Version'                                   | Software version   |

## Adjusting the product settings



### WARNING

Hot coffee, hot steam and hot water can cause scalding. Scalding is a serious burn.

- Use extreme care when handling hot liquid or steam.
- Allow liquid to cool down before drinking.
- In the event of scalding, rinse affected area with cold water and seek medical attention.
- Keep children AWAY.

In the program item 'Product settings' / 'Expert mode' you can make individual settings for all specialty coffees and hot water. The following permanent settings can be made:

| Product                                  | Coffee strength | Amount   | More settings                                       |
|--|-----------------|--|---|
| Ristretto, espresso                      | 10 levels       | Coffee: 0.5 oz – 2.5 oz<br>(15 ml – 80 ml)   | Temperature (low, normal, high)<br>Product name     |
| Coffee                                   | 10 levels       | Coffee: 0.5 oz – 8.0 oz<br>(25 ml – 240 ml)  | Temperature (low, normal, high)<br>Product name     |
| Two ristretti, two espressi, two coffees | –               | Coffee: the amount set for the single product is doubled.  | Temperature (as for single product)<br>Product name |
| Latte macchiato                          | 10 levels       | Coffee: 0.5 oz – 8.0 oz<br>(25 ml – 240 ml)<br>Milk: 0 sec. – 120 sec.<br>Interval: 0 sec. – 60 sec. | Temperature (low, normal, high)<br>Product name     |
| Cappuccino, Flat White                   | 10 levels       | Coffee: 0.5 oz – 8.0 oz<br>(25 ml – 240 ml)<br>Milk: 0 sec. – 120 sec.                               | Temperature (low, normal, high)<br>Product name     |

#### 4 Permanent settings in programming mode

| Product         | Coffee strength | Amount  | More settings                                   |
|-----------------|-----------------|---|---|
| Macchiato       | 10 levels       | Coffee: 0.5 oz – 2.5 oz<br>(15 ml – 80 ml)<br>Milk: 0 sec. – 120 sec. | Temperature (low, normal, high)<br>Product name |
| Portion of milk | –               | Milk: 0 sec. – 120 sec.   | Product name                                    |
| Hot water       | –               | Water: 0.5 oz – 15.0 oz<br>(25 ml – 450 ml)                           | Temperature (low, normal, high)<br>Product name |

Permanent settings in programming mode always follow the same model.

**Example:** Proceed as follows to change the amount of water and coffee strength for one espresso.

- ▶ Press the P button.  
‘Maintenance status’
- ▶ Turn the Rotary Switch until ‘Product settings’ is displayed.
- ▶ Press the Rotary Switch.  
‘Expert mode’
- ▶ Press the Rotary Switch to enter the program item.  
‘Expert mode’
- ▶ Press the ‘Espresso’ button.  
‘Expert mode’ / ‘Espresso’
- ▶ Press the Rotary Switch.  
‘Espresso’
- ▶ Press the Rotary Switch.
- ▶ Turn the Rotary Switch to change the coffee strength setting.
- ▶ Press the Rotary Switch to confirm the setting.
- ▶ Turn the Rotary Switch until the fill volume is in focus.
- ▶ Press the Rotary Switch.
- ▶ Turn the Rotary Switch to change the fill volume setting.
- ▶ Press the Rotary Switch to confirm the setting.
- ▶ Press the ‘Save’ button.  
‘Saved’ appears briefly on the display.  
‘Expert mode’ / ‘Espresso’
- ▶ Press the P button to exit programming mode.

## Adding products to the start screen, duplicating and personalizing

In the program item **'Product settings'** / **'Classics'** you will find all the products stored as standard in your J6. You can move any of these products to your preferred position on the start screen or in the product selector and make it one of your favorites. **You can duplicate** and **personalize** your favorite specialty coffees by giving them a new product name and individual settings (e.g. amount and coffee strength).

**Example:** Proceed as follows to replace **'Latte macchiato'** on the start screen with **'Macchiato'**.

- ▶ Press the P button.  
**'Maintenance status'**
- ▶ Turn the Rotary Switch until **'Product settings'** is displayed.
- ▶ Press the Rotary Switch.  
**'Expert mode'**
- ▶ Turn the Rotary Switch until **'Classics'** is displayed.
- ▶ Press the Rotary Switch to enter the program item.  
**'Add to favourites'**
- ▶ Press the Rotary Switch again.
- ▶ Turn the Rotary Switch until **'Macchiato'** is in focus.
- ▶ Press the Rotary Switch.  
**'Select position'**
- ▶ Press the **'Latte macchiato'** button.  
**'Macchiato' / 'Do you want to replace the current product?'**
- ▶ Press the **'Yes'** button.  
**'Saved'** appears briefly on the display.  
**'Product name'**

**i** You can now give the product you just added a new name.

- ▶ Press the **'Save'** button.  
**'Macchiato'**

**i** You can now change various settings for the product. To do this, briefly press the Rotary Switch to access the various setting options. Confirm the settings by pressing the **'Save'** button.

**i** If you do not want to change any more settings, just press the **'↑'** button.

- ▶ Press the P button to exit programming mode.

## Automatic switch-off

By instructing your J6 to automatically switch itself off, you can cut down your energy consumption. If this function is activated, your J6 switches off automatically after the preset time following the last action on the machine.

You can set the automatic switch-off to 15 minutes, 30 minutes or 1-9 hours.

- ▶ Press the P button.  
‘Maintenance status’
- ▶ Turn the Rotary Switch until ‘Machine settings’ is displayed.
- ▶ Press the Rotary Switch.  
‘Choose language’
- ▶ Turn the Rotary Switch until ‘Switch off after’ is displayed.
- ▶ Press the Rotary Switch to enter the program item.  
‘Switch off after’
- ▶ Turn the Rotary Switch to change the switch-off time.
- ▶ Press the ‘Save’ button.  
‘Saved’ appears briefly on the display.  
‘Switch off after’
- ▶ Press the P button to exit programming mode.

## Energy-saving mode

In the program item ‘Machine settings’ / ‘Save energy’ you can permanently set an energy-saving mode (Energy Save Mode, E.S.M.®):

- ‘Active’
  - Soon after the last preparation, the J6 stops heating up. After about 5 minutes the message ‘Energy Save’ is displayed.
  - Before you can prepare a specialty coffee, specialty coffee with milk, or hot water, the machine must heat up.
- ‘Inactive’
  - All specialty coffees, specialty coffees with milk and hot water can be prepared without having to wait.

**Example:** Proceed as follows to change the energy-saving mode from ‘Active’ to ‘Inactive’.

- ▶ Press the P button.  
‘Maintenance status’
- ▶ Turn the Rotary Switch until ‘Machine settings’ is displayed.
- ▶ Press the Rotary Switch.  
‘Choose language’

- ▶ Turn the Rotary Switch until **'Save energy'** is displayed.
- ▶ Press the Rotary Switch to enter the program item.  
**'Save energy'**
- ▶ Turn the Rotary Switch until **'Inactive'** is displayed.
- ▶ Press the **'Save'** button.  
**'Saved'** appears briefly on the display.  
**'Save energy'**
- ▶ Press the P button to exit programming mode.

## Setting the water hardness

The harder the water is, the more frequently the J6 needs to be descaled. It is therefore important to set the water hardness accurately.

The water hardness was set when the machine was first used. You can change this setting at any time.

The water hardness can be adjusted on a continuous scale between 1 °dH and 30 °dH.

- ▶ Press the P button.  
**'Maintenance status'**
- ▶ Turn the Rotary Switch until **'Machine settings'** is displayed.
- ▶ Press the Rotary Switch.  
**'Choose language'**
- ▶ Turn the Rotary Switch until **'Water hardness'** is displayed.
- ▶ Press the Rotary Switch to enter the program item.  
**'Water hardness'**
- ▶ Turn the Rotary Switch to change the setting.
- ▶ Press the **'Save'** button.  
**'Saved'** appears briefly on the display.  
**'Water hardness'**
- ▶ Press the P button to exit programming mode.

## Display settings

In the program item **'Machine settings'** / **'Display'** you can set the display brightness (as a percentage).

- ▶ Press the P button.  
**'Maintenance status'**
- ▶ Turn the Rotary Switch until **'Machine settings'** is displayed.
- ▶ Press the Rotary Switch.  
**'Choose language'**

#### 4 Permanent settings in programming mode

- ▶ Turn the Rotary Switch until 'Display' is displayed.
- ▶ Press the Rotary Switch to enter the program item.  
'Display'
- ▶ Turn the Rotary Switch to change the setting.
- ▶ Press the 'Save' button.  
'Saved' appears briefly on the display.  
'Display'
- ▶ Press the P button to exit programming mode.

#### Unit for amount of water

In the program item 'Machine settings' / 'Units' you can select the unit used for the amount of water.

**Example:** Proceed as follows to change the unit for the amount of water from 'oz' to 'ml'.

- ▶ Press the P button.  
'Maintenance status'
- ▶ Turn the Rotary Switch until 'Machine settings' is displayed.
- ▶ Press the Rotary Switch.  
'Choose language'
- ▶ Turn the Rotary Switch until 'Units' is displayed.
- ▶ Press the Rotary Switch to enter the program item.  
'Units'
- ▶ Turn the Rotary Switch until 'ml' is displayed.
- ▶ Press the 'Save' button.  
'Saved' appears briefly on the display.  
'Units'
- ▶ Press the P button to exit programming mode.

#### Restore factory settings

In the program item 'Machine settings' / 'Factory setting' the machine can be reset to its factory setting: **All user settings** (apart from the 'filter' and 'water hardness') are reset to factory settings. Your J6 then switches off.

- ▶ Press the P button.  
'Maintenance status'
- ▶ Turn the Rotary Switch until 'Machine settings' is displayed.
- ▶ Press the Rotary Switch.  
'Choose language'
- ▶ Turn the Rotary Switch until 'Factory setting' is displayed.

- ▶ Press the Rotary Switch to enter the program item.  
'Factory setting' / 'Reset the machine to the factory settings?'
- ▶ Press the "Yes" button.  
'Saved' appears briefly on the display.  
Your J6 is switched off.

## Language

In this program item you can set the language used by your J6.

**Example:** Proceed as follows to change the language from 'English' to 'Deutsch'.

- ▶ Press the P button.  
'Maintenance status'
- ▶ Turn the Rotary Switch until 'Machine settings' is displayed.
- ▶ Press the Rotary Switch.  
'Choose language'
- ▶ Press the Rotary Switch to enter the program item.  
'Choose language'
- ▶ Turn the Rotary Switch until 'Deutsch' is displayed
- ▶ Press the "Save" button.  
'Gespeichert' appears briefly on the display.  
'Sprachauswahl'
- ▶ Press the P button to exit programming mode.  
'Bitte wählen'

## Querying information

In the program item 'Machine settings' you can view the following information:

- 'Product counter': Number of prepared specialty coffees, milk and hot water
- 'Maintenance counter': Number of maintenance programs performed (cleaning, descaling etc.)
- 'Version': Software version

**Example:** Proceed as follows to view the number of specialty coffees prepared.

- ▶ Press the P button.  
'Maintenance status'
- ▶ Turn the Rotary Switch until 'Machine settings' is displayed.

#### 4 Permanent settings in programming mode

- ▶ Press the Rotary Switch.  
    'Choose language'
- ▶ Turn the Rotary Switch until 'Product counter' is displayed.
- ▶ Press the Rotary Switch to enter the program item.  
    'Product counter'
- i** Turn the Rotary Switch to view the number of other specialty coffees.
- ▶ Press the P button to exit programming mode.



## 5 Maintenance

### WARNING

Use of maintenance products that are harmful to health and discharge of liquids during maintenance program. Harmful if swallowed. Irritating to eyes and skin.

- ▶ Keep children AWAY.
- ▶ Keep children away from the machine while it is performing a maintenance program.
- ▶ Avoid contact with skin and eyes.
- ▶ Avoid generation of dust. Do not inhale dust.
- ▶ When using do not eat or drink.
- ▶ Keep maintenance products away from food, drink and animal food.
- ▶ Keep container tightly closed and dry. Keep in a cool place.

Your J6 has the following integrated maintenance programs:

- Rinsing the machine
- Rinsing the milk system in the dual spout
- Cleaning the milk system in the dual spout ('Clean the milk system')
- Changing the filter ('Change the filter')  
(only if filter is activated)
- Cleaning the machine ('Clean')
- Descaling the machine ('Descale')  
(only if filter is not activated)

**i** Clean or descale the machine, rinse the milk system or change the filter when you are prompted to do so.

**i** Press the P button to view a list of the maintenance programs ('Maintenance status'). When the bar is completely filled with red, your J6 will prompt you to perform the appropriate maintenance program.

**i** In the interests of hygiene, you should clean the milk system **daily** when you have been preparing milk.

## Rinsing the machine



You can initiate the rinse operation manually at any time.

- ▶ Place a receptacle under the coffee spout.
- ▶ Press the P button.  
**'Maintenance status'**
- ▶ Press the Rotary Switch.  
**'Clean'**
- ▶ Turn the Rotary Switch until **'Rinse'** is displayed.
- ▶ Press the Rotary Switch to initiate the rinse operation.  
**'Machine is rinsing', 'Milk system is being rinsed'**, water flows out of the coffee spout.  
The rinse stops automatically. **'Please select product'** appears on the display.

## Automatic milk system rinsing

15 minutes after milk preparation, the milk system is **automatically** rinsed. Therefore always place a receptacle under the cappuccino frother after preparing milk.

When **'Rinse the milk system'** is displayed, you can start rinsing by pressing the Rotary Switch.

## Cleaning the milk system

To ensure that the cappuccino frother always works properly, you must clean it **daily** when you have been preparing milk

### WARNING

Non-recommended cleaning agents will not optimally remove milk residues. This may cause the cappuccino frother to become blocked and fly off the machine. Discharge of hot steam.



- ▶ Use only original JURA milk system cleaner.

### WARNING

Harmful and irritating cleaning agent. Harmful if swallowed. Irritating to eyes and skin.

- ▶ Keep children AWAY.
- ▶ Avoid contact with skin and eyes.
- ▶ After contact with skin, wash immediately with plenty of water. In case of skin irritation, seek medical advice.
- ▶ After eye contact, immediately flush eyes with plenty of water and seek medical advice.
- ▶ If swallowed, rinse mouth immediately and drink large quantities of water. Do not induce vomiting. Seek medical advice immediately and show label.

- i** JURA milk system cleaner is available from specialized dealers.
- i** To clean the milk system, use the container supplied.

- ▶ Press the P button.  
**'Maintenance status'**
- ▶ Press the Rotary Switch.  
**'Clean'**
- ▶ Turn the Rotary Switch until **'Clean the milk system'** is displayed.
- ▶ Press the Rotary Switch.  
**'Clean the milk system'**
- ▶ Press the Rotary Switch again.
- ▶ Press the **'Start'** button.
- ▶ Remove the milk pipe from the milk container or carton.
- ▶ Add milk system cleaner to the front part of the container up to the **bottom mark** (indicated by ).
- ▶ Then fill with water up to the **upper mark**.
- ▶ Place the container under the cappuccino frother.
- ▶ Turn the setting wheel of the cappuccino frother to the Milk position .

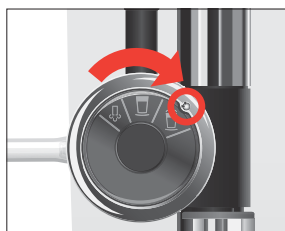
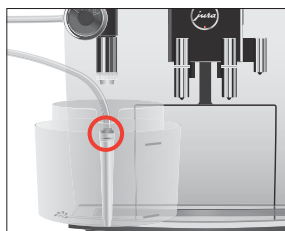
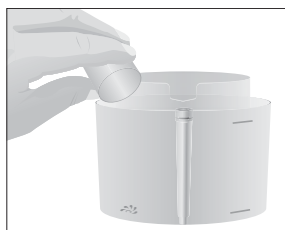

- ▶ Connect the milk pipe to the container.

- i** To connect the milk pipe to the container correctly, the pipe must be fitted with a connector.

- ▶ Press the **'Next'** button.  
**'Milk system is being cleaned'** appears and the cappuccino frother and the milk pipe are cleaned.
- ▶ During the first brief interruption, set the setting wheel of the cappuccino frother to the Milk Foam position .
- 'Water for cleaning milk system'**
- ▶ Rinse the container thoroughly and fill the front part with fresh water up to the **upper mark**.
- ▶ Place this under the cappuccino frother and reconnect the milk pipe to the container.
- ▶ Press the **'Next'** button.  
**'Milk system is being cleaned'** appears and the cappuccino frother and the milk pipe are rinsed with fresh water.  
The start screen is displayed.

## Dismantling and rinsing the cappuccino frother

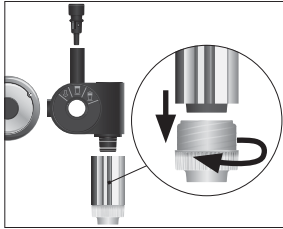

To make sure the cappuccino frother works properly, and in the interests of hygiene, it must be dismantled and rinsed **daily** if you have been preparing milk.

- ▶ Remove the milk pipe and rinse it thoroughly under running water.
- ▶ Carefully pull the cappuccino frother down and off.
- ▶ Dismantle the cappuccino frother into its individual parts.
- ▶ Rinse all the parts under running water. If there are severely dried-on milk residues, firstly immerse the individual parts in a solution of 8.5 oz (250 ml) cold water and 1 capful of JURA milk system cleaner. Then rinse the parts thoroughly.
- ▶ Reassemble the cappuccino frother.

**i** Ensure that all individual parts are correctly and firmly connected to ensure correct operation of the cappuccino frother.

- ▶ Firmly attach the frother to the connector.

## Inserting the filter



Your J6 no longer has to be descaled if you are using the CLEARYL Smart filter cartridge. If you did not insert the filter cartridge the first time you used the machine, you can do this now as follows.

- ▶ Place a receptacle under the hot-water spout.
- ▶ Remove and empty the water tank.
- ▶ Open the filter holder.
- ▶ Fit the filter cartridge extension supplied on top of a CLEARYL Smart filter cartridge .

- ▶ Insert the filter cartridge with its extension into the water tank.
- ▶ Close the filter holder. It will click into place audibly.
- ▶ Fill the water tank with fresh, cold water and reinsert the tank.

**i** The machine automatically detects that you have just inserted the filter cartridge.

'Filter operation' / 'Saved'

'Filter is being rinsed', water flows out of the hot-water spout.

Rinsing of the filter stops automatically after approximately 10 oz (300 ml).

**'Empty drip tray'**

- ▶ Empty the drip tray and put it back into the machine.

**'Filter operation', 'Filter rinsing complete'**

**'Please select product'** appears on the display. Your J6 is once more ready for use.

## Changing the filter

- i** Once the filter cartridge stops working (depending on the water hardness setting), the J6 will prompt you to change the filter.

- i** CLEARYL Smart filter cartridges are available from specialized dealers.

**Precondition:** **'Change filter'** is displayed.

- ▶ Place a receptacle under the hot-water spout.
- ▶ Remove and empty the water tank.
- ▶ Open the filter holder and remove the old CLEARYL Smart filter cartridge and filter extension.
- ▶ Fit the filter cartridge extension on top of a **new** CLEARYL filter cartridge Smart.



- ▶ Insert the filter cartridge with its extension into the water tank.
- ▶ Close the filter holder. It will click into place audibly.
- ▶ Fill the water tank with fresh, cold water and reinsert the tank.

- i** The machine automatically detects that you have just changed the filter cartridge.

**'Change the filter' / 'Saved'**

**'Filter is being rinsed'**, water flows out of the hot-water spout.

**'Empty drip tray'**

- ▶ Empty the drip tray and put it back into the machine.

**'Change the filter', 'Filter rinsing complete'**

**'Please select product'** appears on the display. Your J6 is once more ready for use.

## Cleaning the machine

After 180 preparations or 80 switch-on rinses, the J6 will prompt you to clean it.

 **WARNING**



Non-recommended (e.g. liquid) cleaning agents may contain substances that could damage the machine or leave residues.

- ▶ Use only original JURA cleaning tablets. These are specially formulated for your machine.

 **WARNING**

Harmful and irritating cleaning agent. Harmful if swallowed. Irritating to eyes and skin.

- ▶ Keep children AWAY.
- ▶ Avoid contact with skin and eyes.
- ▶ Avoid generation of dust. Do not inhale dust.
- ▶ After contact with skin, wash immediately with plenty of water. In case of skin irritation, seek medical advice.
- ▶ After eye contact, immediately flush eyes with plenty of water and seek medical advice.
- ▶ If swallowed, rinse mouth immediately and drink large quantities of water. Do not induce vomiting. Seek medical advice immediately and show label.

-  The cleaning program lasts approximately 20 minutes.
-  Do not interrupt the cleaning program. The quality of cleaning will be impaired if you do so.
-  JURA cleaning tablets are available from specialized dealers.

**Precondition:** 'Clean machine' is displayed.

- ▶ Press the P button.  
'Clean'
- ▶ Press the Rotary Switch.
- ▶ Press the 'Start' button.
- ▶ Press the 'Start' button again.  
'Empty coffee grounds container'
- ▶ Empty the drip tray and coffee grounds container and put them back into the machine.  
'Press the Rotary Switch'



- ▶ Place one receptacle under the coffee spout and another under the cappuccino frother.
- ▶ Press the Rotary Switch.  
'Machine is being cleaned', water flows out of the coffee spout.  
 The operation is interrupted, 'Add cleaning tablet'.
- ▶ Open the cover of the filler funnel for ground coffee.
- ▶ Insert a JURA cleaning tablet into the filler funnel.
- ▶ Close the cover of the filler funnel.
- ▶ 'Press the Rotary Switch'
- ▶ Press the Rotary Switch.  
'Machine is being cleaned', water flows repeatedly out of the coffee spout and the cappuccino frother.  
 The operation stops automatically.  
'Empty coffee grounds container'
- ▶ Empty the drip tray and coffee grounds container and put them back into the machine.  
 Cleaning is now complete. The start screen is displayed.

## Descaling the machine

The J6 builds up deposits of limescale over time and automatically prompts you to descale it when necessary. The degree of calcification depends on the hardness of your water.

- i** If you are using a CLEARYL Smart filter cartridge, you will not be prompted to descale.

---

### **⚠ WARNING**

Non-recommended descaling agents (e.g. vinegar) may contain substances that could damage the machine or leave residues.

- ▶ Use only original JURA descaling tablets. These are specially formulated for your machine.

---

### **⚠ WARNING**

Harmful and irritating descaling agent. Harmful if swallowed. Irritating to eyes and skin.

- ▶ Keep children AWAY.
- ▶ Avoid contact with skin and eyes.
- ▶ Avoid generation of dust. Do not inhale dust.
- ▶ After contact with skin, wash immediately with plenty of water. In case of skin irritation, seek medical advice.
- ▶ After eye contact, immediately flush eyes with plenty of water. Remove contact lenses. Seek medical advice.
- ▶ If swallowed, rinse mouth immediately and drink large quantities of water. Do not induce vomiting. Seek medical advice immediately and show label.

---

### **NOTICE**

If the descaling operation is interrupted, there may be damage to the machine.

- ▶ Allow the descaling program to run to the end.

- 
- i** The descaling program lasts approximately 45 minutes.
  - i** JURA descaling tablets are available from specialized dealers.
  - i** If the descaling agent comes into contact with sensitive surfaces (e.g. marble), damage cannot be ruled out. Clean up any splashes immediately.

**Precondition:** 'Decalcify machine' is displayed.

- ▶ Press the P button.  
'Descale'
- ▶ Press the Rotary Switch.
- ▶ Press the 'Start' button.
- ▶ Press the 'Start' button again.  
'Empty drip tray'



- ▶ Empty the drip tray and coffee grounds container and put them back into the machine.

‘Pour descaling agent into water tank’

- ▶ Remove and empty the water tank.
- ▶ Completely dissolve 3 JURA descaling tablets in a receptacle holding 17 oz (500 ml) of water. This may take several minutes.
- ▶ Pour the solution into the **empty** water tank and insert it into the machine.

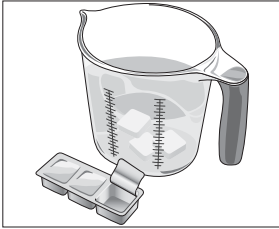

- ▶ Place one receptacle under the hot-water spout and another under the cappuccino frother.

‘Press the Rotary Switch’

- ▶ Press the Rotary Switch.

‘Machine is being descaled’ appears and water flows repeatedly out of the hot-water spout and the cappuccino frother.

The operation is interrupted, ‘Empty drip tray’.

- ▶ Empty the drip tray and coffee grounds container and put them back into the machine.

‘Fill water tank’

- ▶ Remove the water tank and rinse it thoroughly.

- ▶ Fill the water tank with fresh, cold water and reinsert the tank.

‘Press the Rotary Switch’

- ▶ Place a receptacle under the cappuccino frother, the coffee spout and the hot-water spout.

- ▶ Press the Rotary Switch.

‘Machine is being descaled’, The descaling operation is continued.

The operation is interrupted, ‘Empty drip tray’.

- ▶ Empty the drip tray and coffee grounds container and put them back into the machine.

Descaling is now complete. The start screen is displayed.

- i** If the descaling operation stops unexpectedly, rinse the water tank thoroughly.



## Cleaning the bean container

Coffee beans may be covered with a slight oil film which remains on the walls of the bean container. These traces may negatively affect the coffee result. For this reason clean the bean container from time to time.

**Precondition:** 'Fill bean container' is displayed.

- ▶ Switch the machine off with the On/Off button .
- ▶ Open the bean container cover and remove the aroma preservation cover.
- ▶ Clean the bean container with a soft, dry cloth.
- ▶ Fill the bean container with coffee beans, then close the aroma preservation cover and the bean container cover.

## Descaling the water tank

Limescale deposits may form in the water tank. To ensure correct function of the machine, descale the water tank from time to time.

- ▶ Remove the water tank.
- ▶ If you use a CLEARYL Smart filter cartridge, remove this.
- ▶ Completely fill the water tank and dissolve 3 JURA descaling tablets in it.
- ▶ Leave the water tank with the descaling solution for several hours (e.g. overnight).
- ▶ Empty the water tank and rinse it thoroughly.
- ▶ If you use a CLEARYL Smart filter cartridge, insert this again.
- ▶ Fill the water tank with fresh, cold water and reinsert the tank.

## 6 Display messages

| Message                           | Cause/Result   | Action  |
|-----------------------------------|--|---|
| 'Fill water tank'                 | The water tank is empty. You cannot prepare any products.  | ▶ Fill the water tank (see Chapter 3 'Daily operation – Filling the water tank').   |
| 'Empty coffee grounds container'  | The coffee grounds container is full. You cannot prepare any products.   | ▶ Empty the coffee grounds container and the drip tray (see Chapter 3 'Daily operation – Daily maintenance').   |
| 'Drip tray not fitted'            | The drip tray is not inserted correctly or is not inserted at all. You cannot prepare any products.            | ▶ Fit the drip tray.  |
| 'Fill bean container'             | The bean container is empty. You cannot prepare any specialty coffees, but you can prepare hot water and milk. | ▶ Fill the bean container (see Chapter 1 'Preparing and using for the first time – Filling the bean container').  |
| 'Rinse the milk system'           | The J6 requests a milk system rinse.   | ▶ Press the Rotary Switch to start rinsing or wait 15 minutes until rinsing starts automatically (see Chapter 5 'Maintenance – Automatic milk system rinsing'). |
| 'Change filter'                   | The filter cartridge no longer works. The J6 is prompting a filter change.                                     | ▶ Replace the CLEARYL Smart filter cartridge (see Chapter 5 'Maintenance – Changing the filter').   |
| 'Clean machine'                   | The J6 is prompting you to clean it.   | ▶ Perform cleaning (see Chapter 5 'Maintenance – Cleaning the machine').  |
| 'Decalcify machine'               | The J6 is prompting you to descale it.   | ▶ Perform descaling (see Chapter 5 'Maintenance – Descaling the machine').  |
| 'Not enough ground coffee'        | There is insufficient ground coffee in the machine; the J6 stops the operation.                                | ▶ The next time you prepare a beverage, add more ground coffee (see Chapter 2 'Preparation – Ground coffee').   |
| 'Machine too hot for maintenance' | The system is too hot to start a maintenance program.  | ▶ Wait for several minutes until the system has cooled or prepare a specialty coffee or hot water.  |

## 7 Troubleshooting

| Problem  | Cause/Result  | Action  |
|--|---|---|
| Insufficient foam is produced when the milk is frothed or milk sprays from the cappuccino frother. | The cappuccino frother is dirty.  | <ul style="list-style-type: none"> <li>▶ Clean the cappuccino frother (see Chapter 5 'Maintenance – Cleaning the milk system').</li> <li>▶ Dismantle and rinse the cappuccino frother (see Chapter 5 'Maintenance – Dismantling and rinsing the cappuccino frother').</li> </ul>  |
| Coffee only comes out in drips when it is being prepared.  | The coffee is ground too finely and obstructs the system. The water hardness may not have been correctly set.             | <ul style="list-style-type: none"> <li>▶ Set the grinder to a coarser setting (see Chapter 2 'Preparation – Adjusting the grinder').</li> <li>▶ Perform descaling (see Chapter 5 'Maintenance – Descaling the machine').</li> </ul>   |
| 'Fill water tank' is displayed although the water tank is full.                                    | The water tank float is trapped.  | <ul style="list-style-type: none"> <li>▶ Descale the water tank (see Chapter 5 'Maintenance – Descaling the water tank').</li> </ul>  |
| Little or no water or steam comes out of the cappuccino frother. The pump is very quiet.           | The connector of the cappuccino frother may be blocked by milk residues or limescale fragments loosened during descaling. | <ul style="list-style-type: none"> <li>▶ Remove the cappuccino frother.</li> <li>▶ Unscrew the black connector with the aid of the hexagonal hole on the measuring spoon for ground coffee.</li> <li>▶ Clean the connector thoroughly.</li> <li>▶ Screw the connector back on by hand.</li> <li>▶ Carefully tighten it using the hexagonal hole on the measuring spoon, turning by no more than a quarter of a rotation.</li> </ul> |
| Grinder is making a very loud noise.   | There are foreign objects in the grinder.   | <ul style="list-style-type: none"> <li>▶ Contact customer support in your country (see Chapter 11 'JURA contact details / Legal information').</li> </ul>   |
| 'Error 2' or 'Error 5' is displayed.   | If the machine has been exposed to the cold for a long period of time, heating may be disabled for safety reasons.        | <ul style="list-style-type: none"> <li>▶ Warm the machine at room temperature.</li> </ul>   |

| Problem                               | Cause/Result | Action  |
|---------------------------------------|--------------|---|
| Other 'Error' messages are displayed. | -            | <ul style="list-style-type: none"> <li>▶ Switch the J6 off with the On/Off button . Contact customer support in your country (see Chapter 11 'JURA contact details / Legal information').</li> </ul> |

**i** If you were unable to solve the problem, contact customer support in your country (see Chapter 11 'JURA contact details / Legal information').

## 8 Transport and environmentally friendly disposal

### Transport / Emptying the system



Keep the packaging for your J6. It should be used to protect the machine during transport.

In order to protect the J6 from frost during transport, the system must be emptied.

- ▶ Remove the milk pipe from the cappuccino frother.
- ▶ Place a receptacle under the cappuccino frother.
- ▶ Turn the Rotary Switch until '1 portion milk' is in focus.
- ▶ Press the Rotary Switch.

'1 portion milk' appears and hot steam is discharged from the cappuccino frother.

- ▶ Remove and empty the water tank.
- ▶ Turn the Rotary Switch until '60 sec.' is displayed.

Steam will continue to be discharged from the cappuccino frother until the system is empty.

'Fill water tank'

- ▶ Press the On/Off button .
- Your J6 is switched off.

### Disposal

Please dispose of old machines in an environmentally neutral way.



## 9 Technical data

|  |   |
|--|---|
| Voltage  | 120 V ~, 60 Hz  |
| Power  | 1450 W  |
| Conformity mark                                  |  |
| Energy consumption<br>'Save energy' / 'Active'   | approx. 6 Wh  |
| Energy consumption<br>'Save energy' / 'Inactive' | approx. 11 Wh   |
| Pump pressure                                    | static, max. 15 bar   |
| Holding capacity of water tank                   | 71 oz (2.1 l)   |
| Holding capacity of bean container               | 8.8 oz (250 g)  |
| Holding capacity of coffee grounds container     | max. 16 portions  |
| Cord length                                      | approx. 47 in.<br>(approx. 1.2 m)   |
| Weight   | approx. 23.6 lb<br>(approx. 10.7 kg)  |
| Dimensions (W × H × D)                           | 11.2 × 13.5 × 17 in.<br>(28.5 × 34.2 × 43.3 cm)                                   |

**Directives** The machine complies with the following directives:

- Standard UL 1082
- Canadian Standard CSA C22.2 No. 64

## 10 Index

### A

- Adding products to the start screen 27
- Addresses 52
- Adjusting the product settings 25
- Aroma preservation cover
  - Bean container with aroma preservation cover 8
- Automatic switch-off 28

### B

- Bean container
  - Bean container with aroma preservation cover 8
  - Cleaning 42
  - Filling 10
- Bus bar
  - Technical data 47
- Button
  - On/Off button 9
  - P button (programming) 9

### C

- Cappuccino 17
- Cappuccino frother cleaning
  - Cleaning the milk system 34
- Changing the product assigned to a button 27
- Cleaning
  - Bean container 42
  - Machine 38
- CLEARYL Smart filter cartridge
  - Change 37
  - Insert 36
- Coffee 17
  - Two coffees 17
- Coffee grounds container 8
- Coffee spout
  - Height- and width-adjustable coffee spout 8
- Consistency of grind
  - Adjusting the grinder 19
  - Grinder adjustment switch 8
- Contact details 52

### Cover

- Bean container 8
- Filler funnel for ground coffee 8
- Storage compartment 8
- Water tank 8
- Cup platform 8
- Customer support 52

### D

- Daily maintenance 22
- Descaling
  - Machine 40
  - Water tank 42
- Dismantling
  - Cappuccino frother 36
- Dismantling and rinsing
  - the cappuccino frother 36
- Display 9
- Display messages 43
- Display settings 29
- Disposal 46
- Double product 17
- Drip tray 8

### E

- Emptying the system 46
- Energy-saving mode 28
- Errors
  - Troubleshooting 44
- Espresso 17
  - Two espressi 17
- Espresso macchiato 17

### F

- Factory settings
  - Restore factory settings 30
- Filler funnel
  - Filler funnel for ground coffee 8
- Filling
  - Bean container 10
  - Water tank 21
- Filter
  - Change 37
  - Insert 36
- First-time use 11
  - With filter cartridge activation 12
  - Without filter cartridge activation 13



Flat white 17  
 Frother  
   Cappuccino frother 8

**G**

Grinder adjustment switch 8  
 Ground coffee 18  
   Measuring spoon for ground coffee 8

**H**

Homepage 10  
 Hotline 52  
 Hot water 20  
 Hot-water spout 8

**I**

Important safeguards  
   Safety 4  
 Instant coffee  
   Ground coffee 18  
 Interchangeable milk spout 8  
 Internet 10

**J**

JURA  
   Contact details 52  
   Internet 10

**L**

Language 31  
 Latte macchiato 17

**M**

Machine  
   Cleaning 38  
   Daily maintenance 22  
   Descaling 40  
   Regular maintenance 22  
   Rinsing 34  
   Setting up 10  
   Switching off 23  
   Switching on 21  
 Maintenance 33  
   Daily maintenance 22  
   Regular maintenance 22  
 Measuring spoon for ground coffee 8  
 Messages, display 43  
 Milk  
   Connecting milk 14  
 Milk spout 8

Milk system  
   Cleaning 34  
 Milk system rinsing 34

**P**

Permanently setting the water for the cup  
   size 19  
 Permanent settings in programming mode  
   24  
 Personalising products 27  
 Power cord 8  
 Preparation 15, 17  
   At the touch of a button 16  
   Caffè latte 17  
   Cappuccino 17  
   Coffee 17  
   Espresso 17  
   Flat white 17  
   Ground coffee 18  
   Hot water 20  
   Latte macchiato 17  
   Macchiato 17  
   Ristretto 17  
   Two coffees 17  
   Two espressi 17  
   Two ristretti 17  
   Two specialty coffees 17  
   Using the product selector 16  
 Preparation options 16  
 Problems  
   Troubleshooting 44  
 Product selector view 16  
 Product settings  
   Adjusting 25  
 Programming mode 24  
   Adding products to the start screen 27  
   Automatic switch-off 28  
   Display settings 29  
   Duplicating products 27  
   Energy-saving mode 28  
   Language 31  
   Querying information 31  
   Restore factory settings 30  
   Setting the water hardness 29  
   Unit for amount of water 30

**Q**

Querying information 31

## R

- Regular maintenance 22
- Rinsing
  - Machine 34
- Ristretto 17
  - Two ristretti 17
- Rotary Selection 16
- Rotary Switch 9

## S

- Safety
  - Important safeguards 4
- Service socket 8
- Settings
  - Permanent settings in programming mode 24
- Setting up
  - Setting up the machine 10
- Short operating instructions 10
- Spout
  - Hot-water spout 8
- Switching off 23
- Switching on 21
- Switch-off
  - Automatic switch-off 28
- Symbol description 3

## T

- Technical data 47
- Tel 52
- Transport 46
- Troubleshooting 44
- Two products 17

## U

- Unit for amount of water 30
- Use, First-time 11

## W

- Water hardness
  - Determining the water hardness 10
  - Setting the water hardness 29
- Water tank 8
  - Descaling 42
  - Filling 21
- Website 10

- intentionally blank -

## 11 JURA contact details / Legal information

## 11 JURA contact details / Legal information

JURA Elektroapparate AG  
 Kaffeeweltstrasse 10  
 CH-4626 Niederbuchsiten  
 Switzerland

|                     | USA: JURA Inc.  | Canada: FAEMA  |
|---------------------|---|--|
| Customer Service    |   |  |
| Phone               | 1-800-220-5701  | 1-(855)-544-8600   |
| E-Mail              | info@us.jura.com  | info@juracanada.ca   |
| Opening Hours (EST) | Mon – Thu 9 am – 9 pm,<br>Fri 9 am – 8 pm,<br>Sat 9 am – 5 pm |  |
| Distributor Address | 20 Craig Road<br>Montvale, NJ 07645                           | 115 Matheson Boulevard East<br>Mississauga, Ontario, L4Z 1X8 |
| Phone               | 001 (201) 767-3999  | 1-(905)-501-8600   |
| Fax                 | 001 (201) 767-9684  |  |
| Internet            | www.us.jura.com   | www.ca.jura.com  |

@ You will find additional contact details for your country at  
[www.jura.com](http://www.jura.com).

**Technical changes** We reserve the right to make technical changes. The diagrams used in these instructions for use are for illustration purposes only and do not represent the original colors of the machine. Some details of your J6 may vary.

**Feedback** Your opinion is important to us! Use the contact details at  
[www.jura.com](http://www.jura.com).

**Copyright** The instructions for use contain information which is protected by copyright. It is not permitted to photocopy these instructions for use or translate them into another language without the prior written consent of JURA Elektroapparate AG.